

2J4847P

Cellular/LTE and 2.4/5.0 GHZ ISM Adhesive Mount

Key Features

Cable 1: CELLULAR/LTE

- 698-960 MHz
- 1710-2170 MHz
- 2500-2700 MHz

Cable 2: 2.4/5.0 GHz ISM

- 2410-2490 MHz
- 4920-5925 MHz

Adhesive Mount

Ground Plane Independent

Customizable Cable and Connector

Dimensions 83 x 35 x 13.3 mm



Note: Antenna 2J4847PR equipped with 10K resistor for antenna detection is available.



1. Antenna and electrical specifications

Cable 1

Parameters	CELLULAR/LTE Antenna		
Standards	2G,3G and 4G		
Band (MHz)	700/850/900	1700/1800/1900/2100	2600
Frequency (MHz)	698-960	1710-2170	2500-2700
Return Loss (dB)	~-13.1	~-16.7	~-11.6
VSWR	~1.9:1	~1.4:1	~1.8:1
Efficiency (%)	~50	~47	~27
Peak Gain (dBi)	~-2.0	~-1.0	~-0.6
Average Gain (dB)	~-3.0	~-3.2	~-5.6
Impedance (Ohm)	50		
Polarisation	Linear		
Radiation Pattern	Omni-Directional		
Max. Input Power (W)	25		
Connector Type	SMA-Male Standard (Other Connectors Available)		
Cable Length	300 cm Standard (Any Cable Length Available)		
Cable Type	LMR100 Standard (Other Cables Available)		

Cable 2

Parameters	2.4/5.0 GHz ISM Antenna	
Standards	WiFi, BT, ZigBee, ISM	
Band (MHz)	2.4 Ghz	5.0 Ghz
Frequency (MHz)	2410-2490	4920-5925
Return Loss (dB)	~-20.5	~-18.5
VSWR	~1.2:1	~1.3:1
Efficiency (%)	~42	~27
Peak Gain (dBi)	~-2.5	~-0.5
Average Gain (dB)	~-3.7	~-5.6
Impedance (Ohm)	50	
Polarisation	Linear	
Radiation Pattern	Omni-Directional	
Max. Input Power (W)	25	
Connector Type	RP-SMA-Male Standard (Other Connectors Available)	
Cable Length	300 cm Standard (Any Cable Length Available)	
Cable Type	LMR100 Standard (Other Cables Available)	

Antenna Measurement Conditions:

Mounted on 30 x 30 x 0.25 cm ABS Plate
 200 cm of Cable LMR100
 Measured in Certified CTIA 3D Anechoic Chamber

2. Mechanical and environmental specifications

Specifications	2J4847P
Mounting Type	Adhesive Mount
Dimensions (mm)	83 x 35 x 13.3
Radome	ABS UV Stable
Radome color	Black
Operating Temperature (C)	-40 to +85
Storage Temperature (C)	-40 to +85
Substance Compliance	RoHS

3. Antenna parameters

Table 1: CELLULAR/LTE

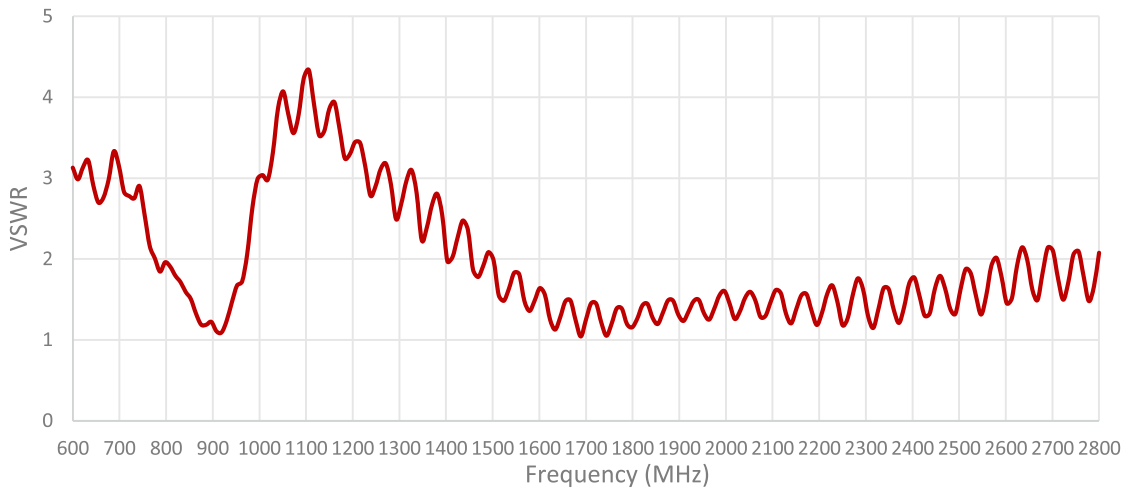
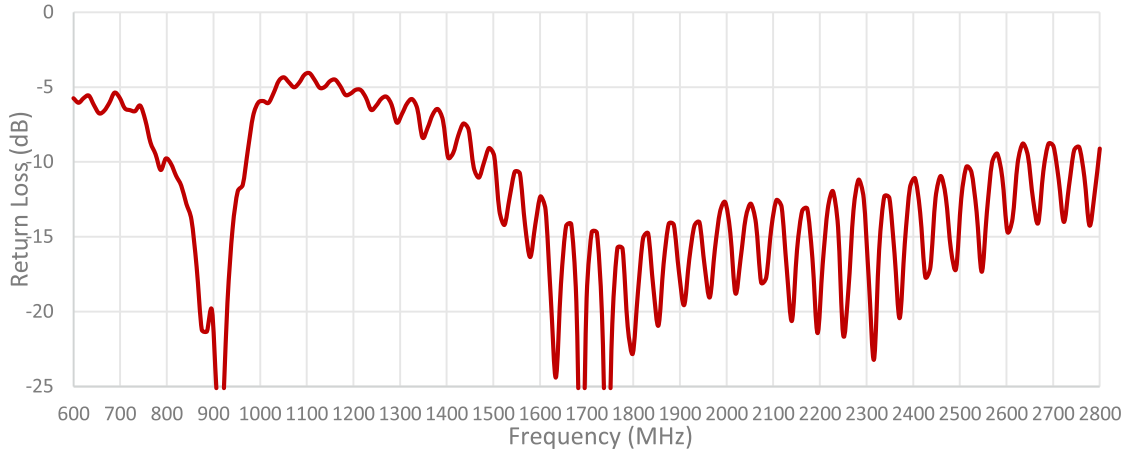

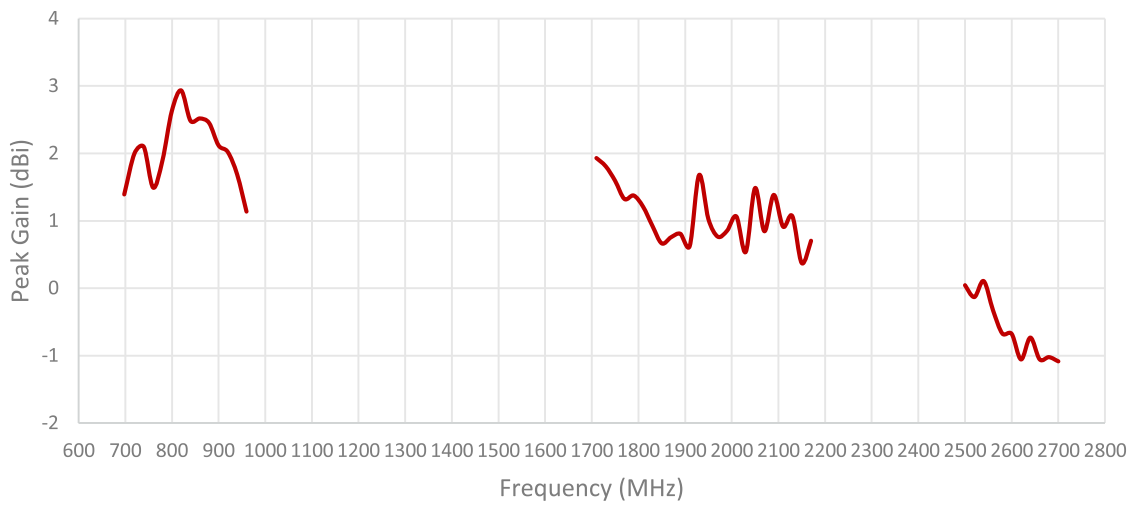
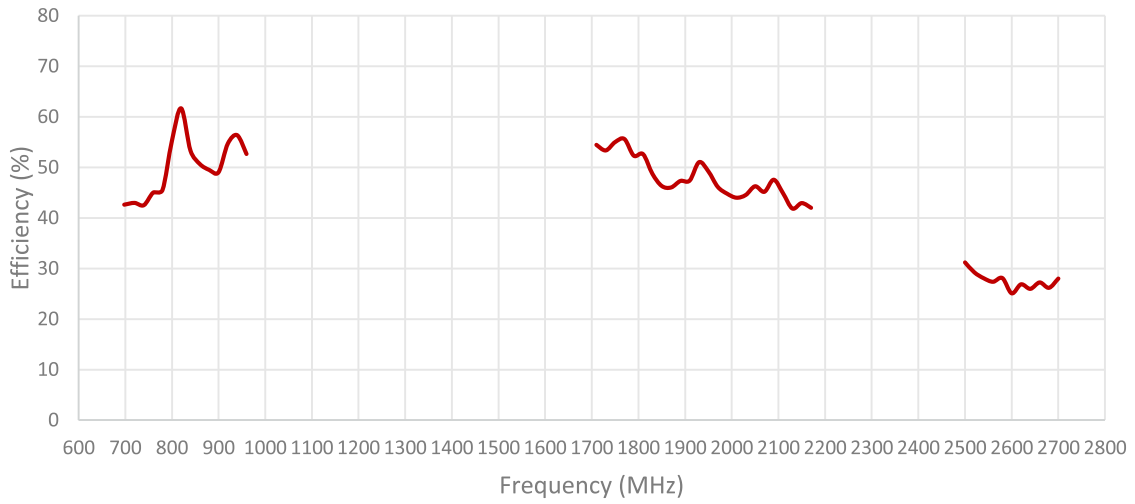

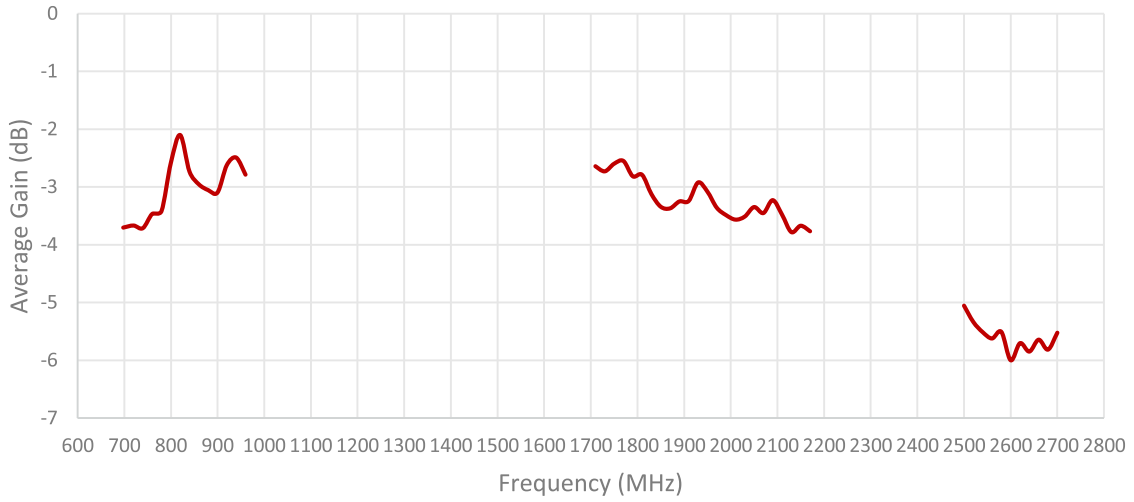

Cable 2: 2.4/5.0 GHz ISM

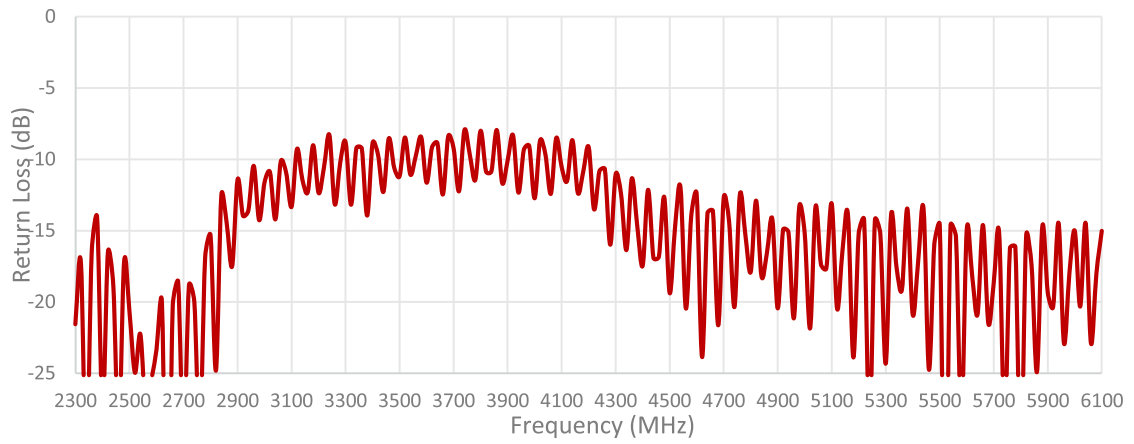

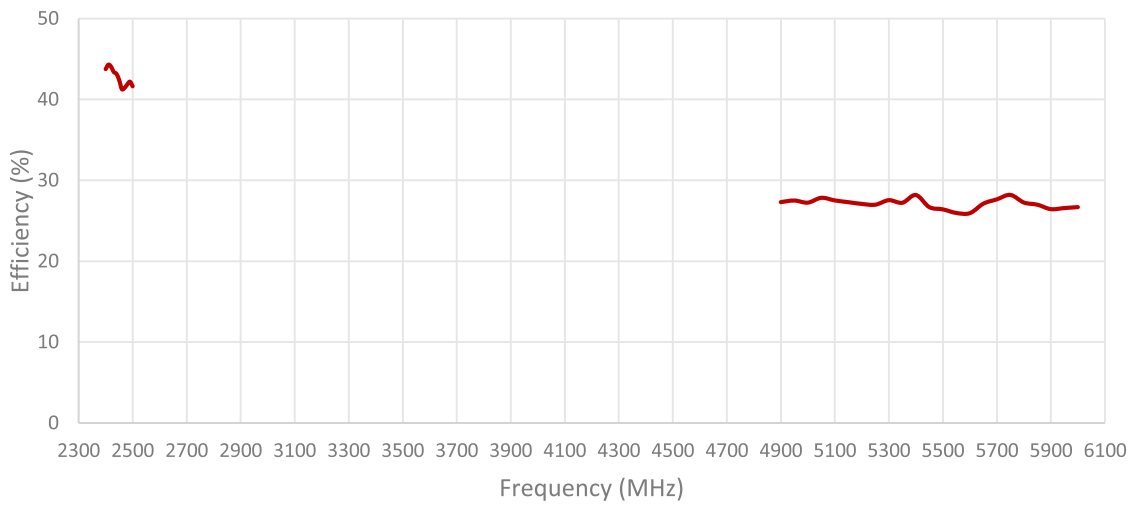
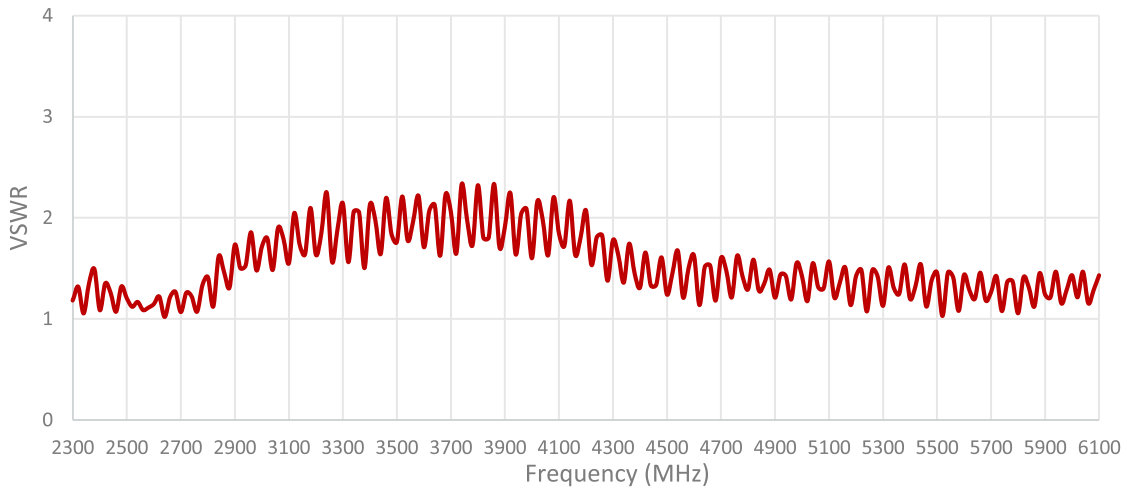

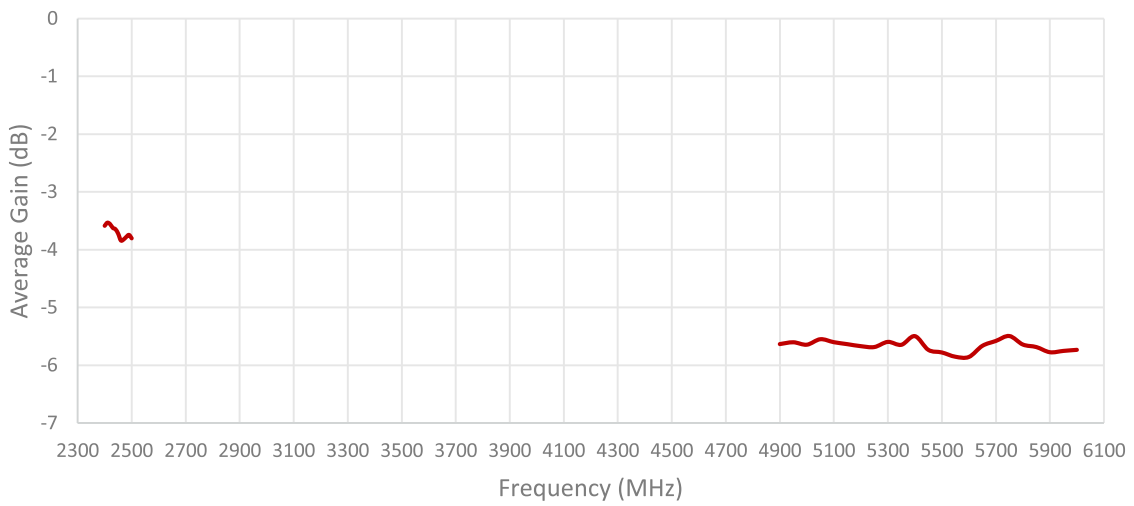
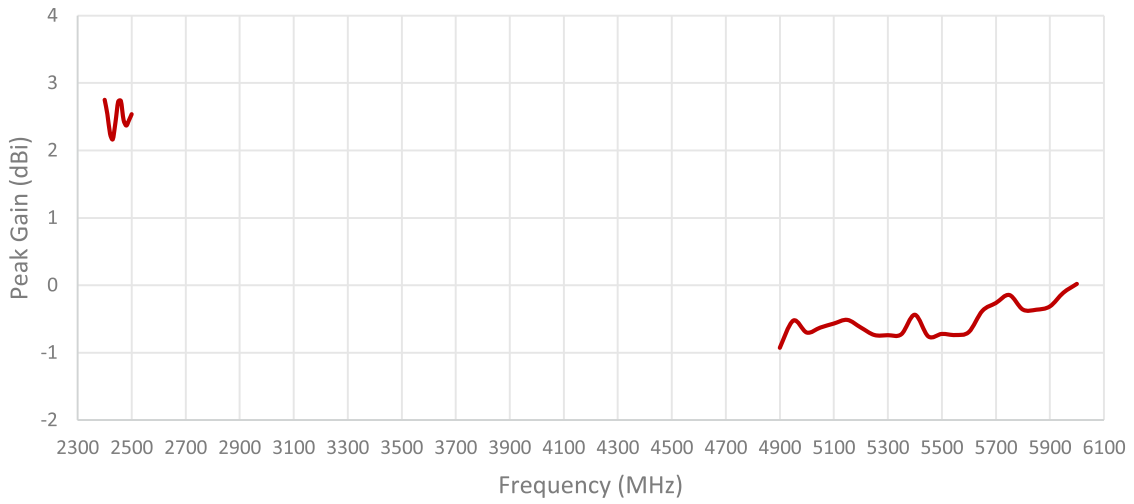

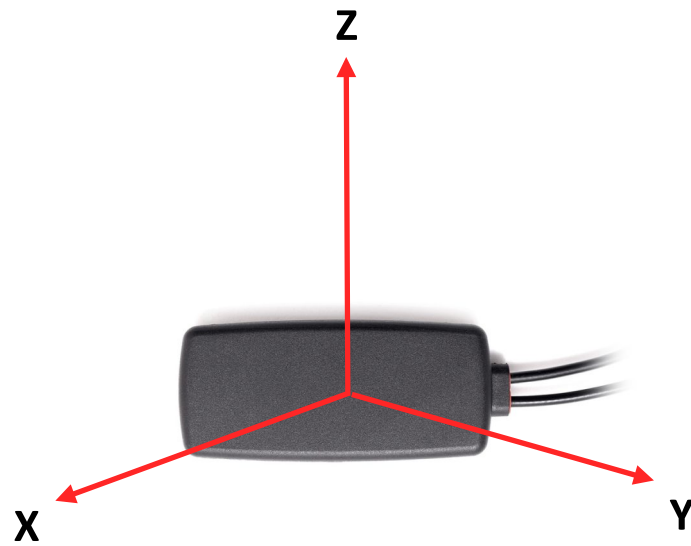

Radiation pattern reference

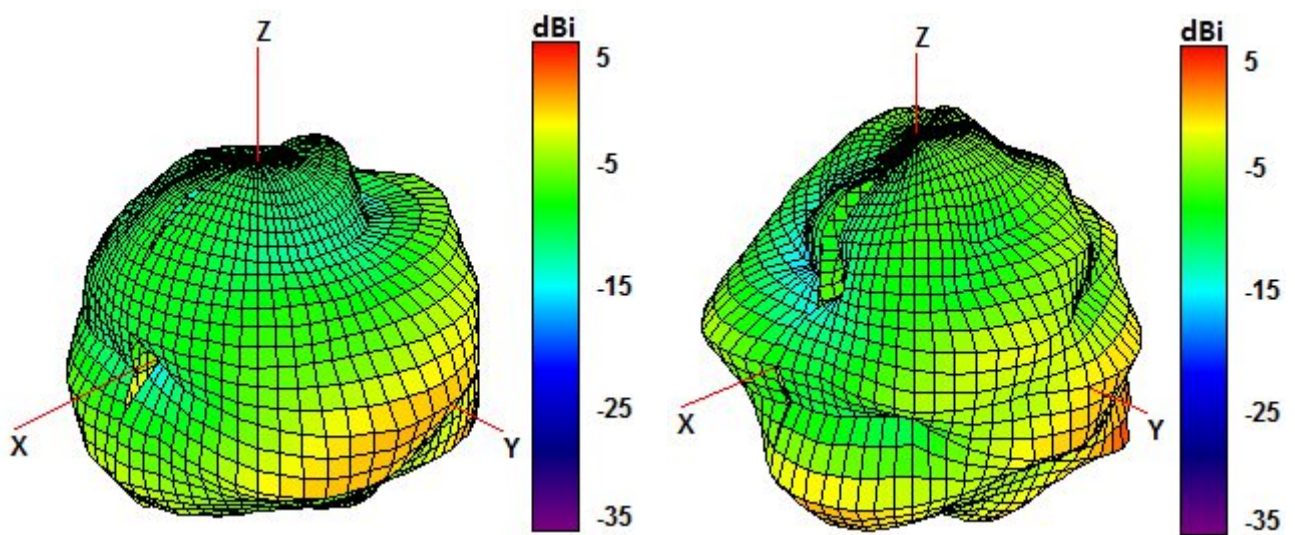

750 and 850 MHz Radiation pattern

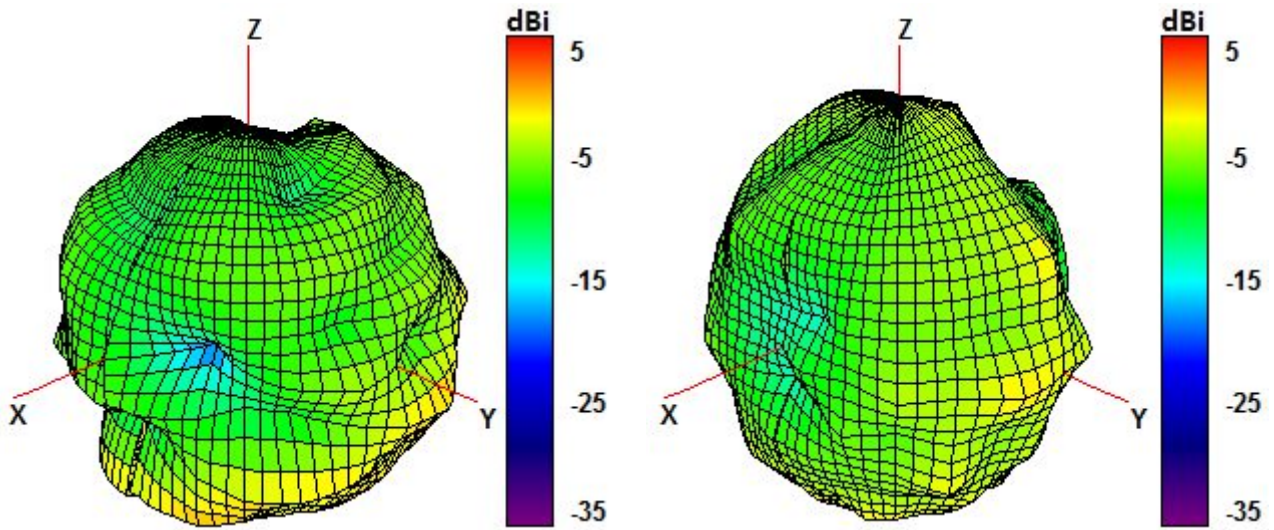

940 and 1750 MHz Radiation pattern

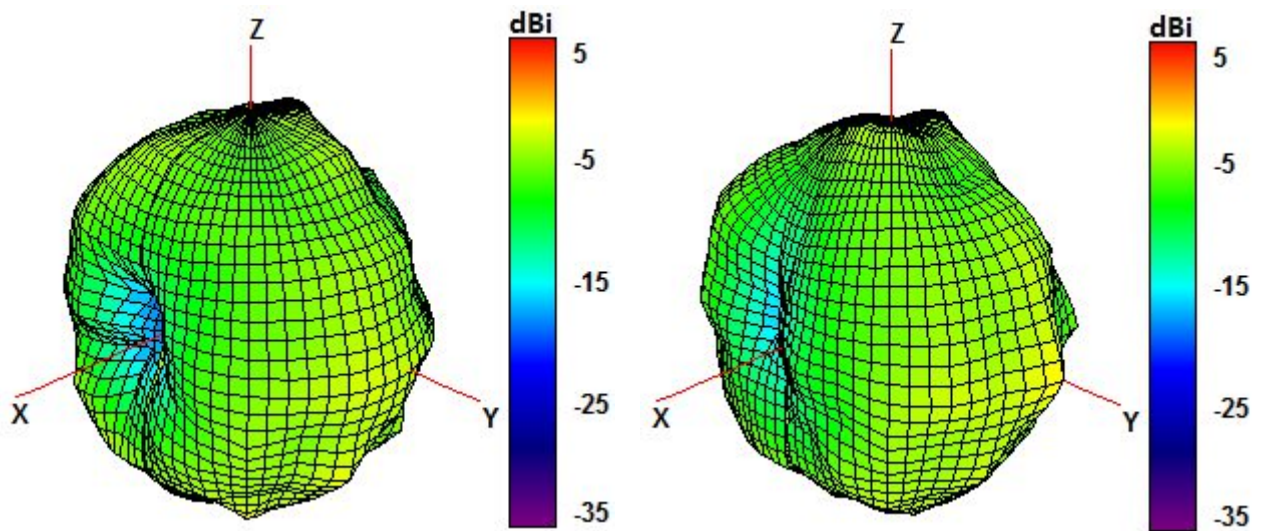

1850 and 1950 MHz Radiation pattern

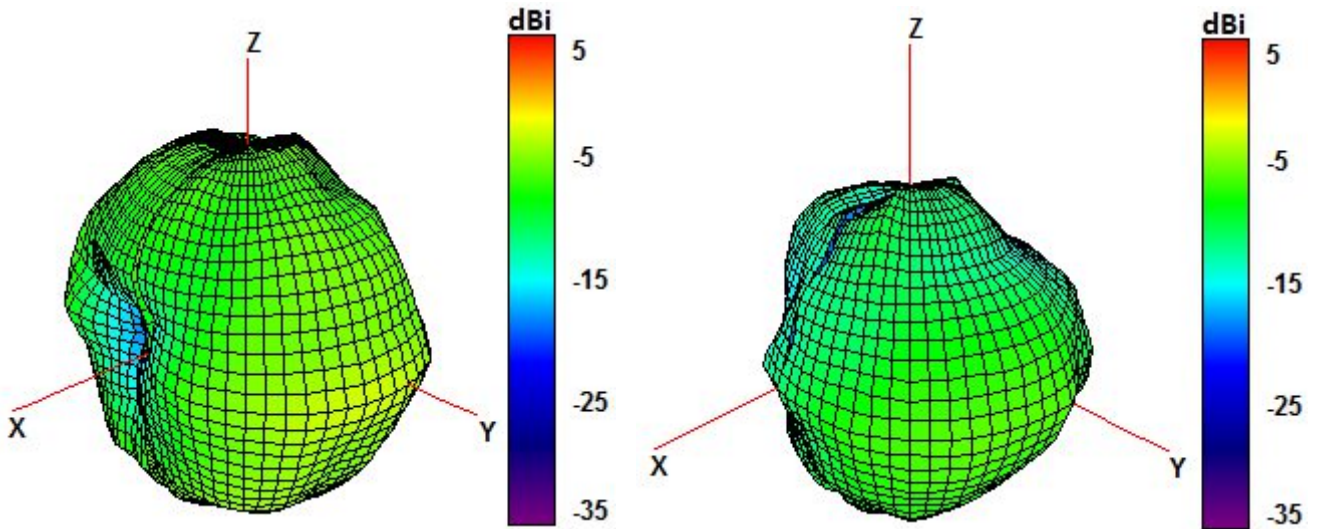

2100 and 2600 MHz Radiation pattern

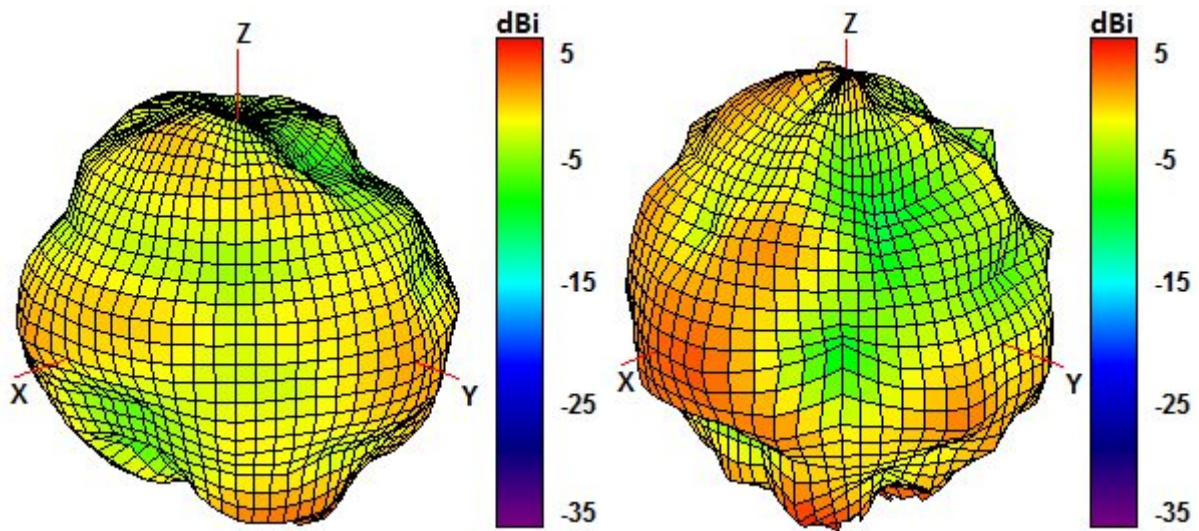

2450 and 5500 MHz Radiation pattern

4. Antenna drawings

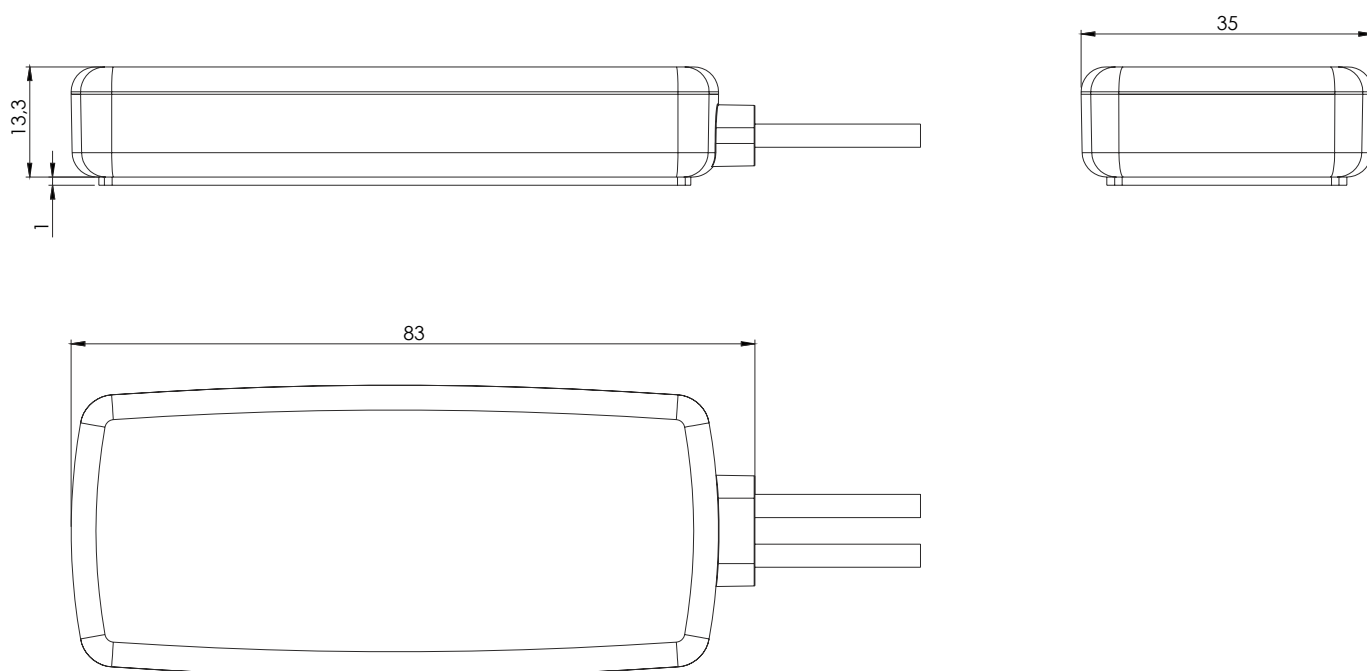

5. Antenna Images

