

# 2J300M

## (DATASHEET)

<b>Type</b>	Multiband Antenna
<b>Frequencies</b>	LTE (699-960MHz/1710-2690MHz)
<b>Mounting</b>	Magnetic Mount
<b>Revision</b>	00



*Tipul*  
P. Tipul

# 1. SPECIFICATION

## 1.1. Electrical Specifications

Frequencies	LTE (699-960MHz/1710-2690MHz)
Impedance	50 Ohms
Polarization	VERTICAL
Gain	2.2 dBi Max
VSWR*	<3.2:1
Power handling	35W
Operating temperature	-40°C to +85°C

\*Measured on 30x30cm ground plane

## 1.2. Connection Specification

Connector type: FME female

Cable: RG174U

Cable length: 250 cm

For different cable length and connector type ask our sales team.

## 1.3. Mechanical Specifications and Dimensions

Material: PP (polypropylen)  
 Max. dimensions: 31mm x 72mm (D x H)  
 Weight: 75g 'weight with connection above'  
 Colour: Black (for different colours please ask our sales team)

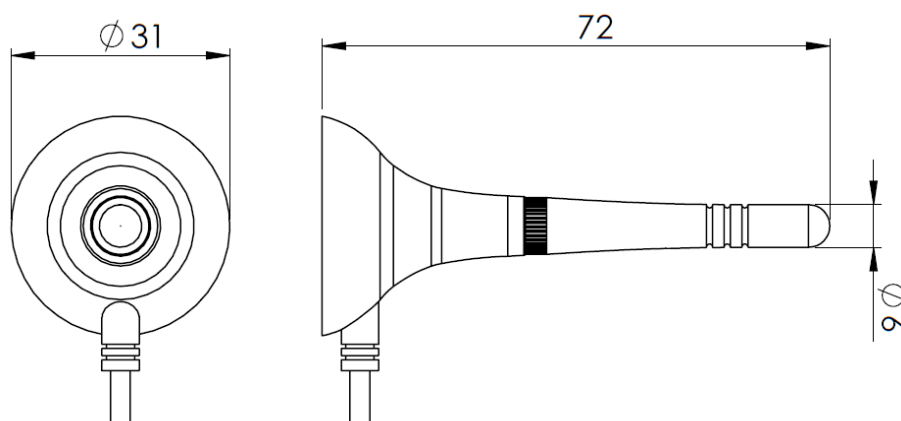

## 2. MEASUREMENT

- Measurement made with 250cm cable length RG174 placed on 30x30cm metallic ground plane.

### 2.1. S11

VSWR

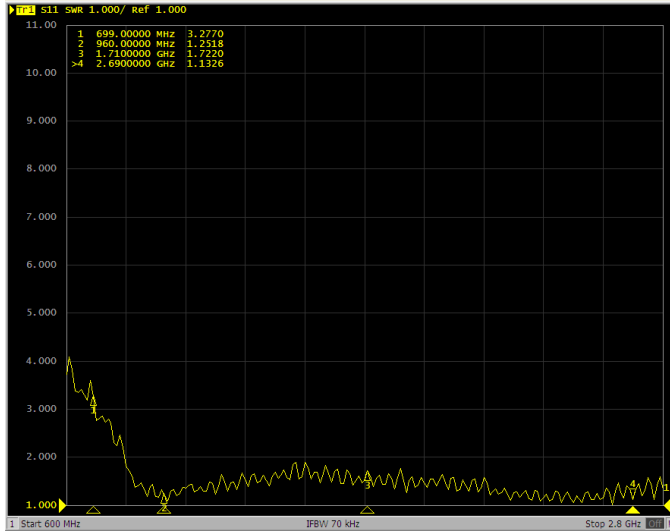

Log Mag

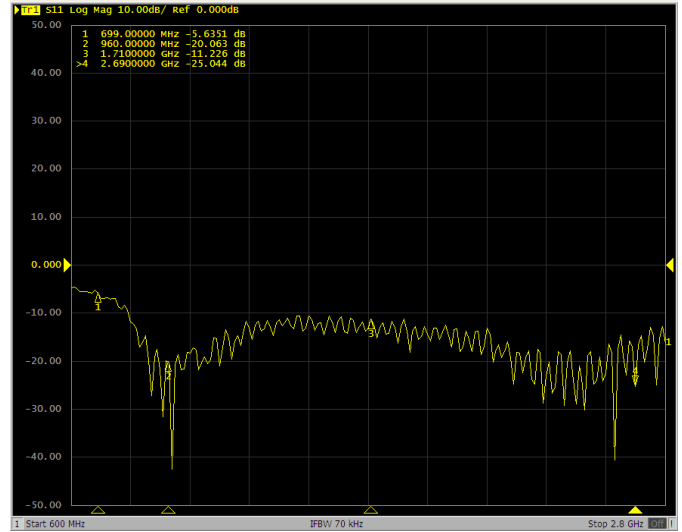

### 2.2. 3D Spherical Antenna Gain (dBi)

Freq = 0.6990GHz Az= 45 EL= 5

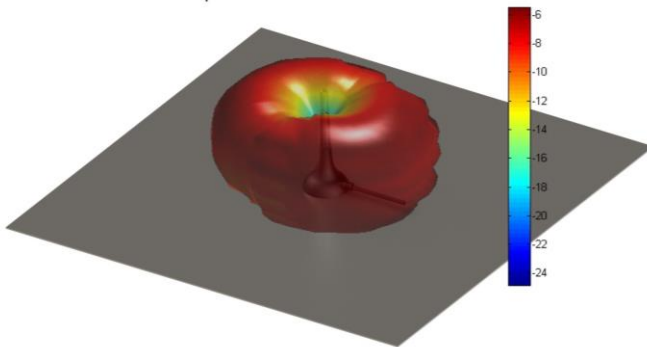

Freq = 0.754GHz Az= 45 EL= 45

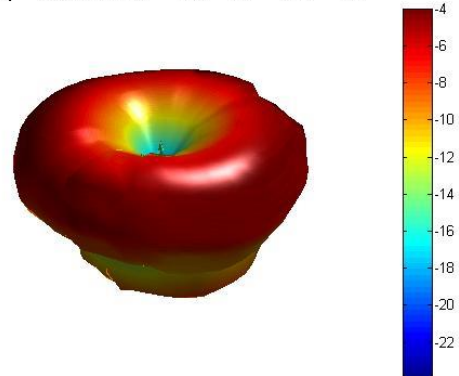

Freq = 0.798GHz Az= 45 EL= 45

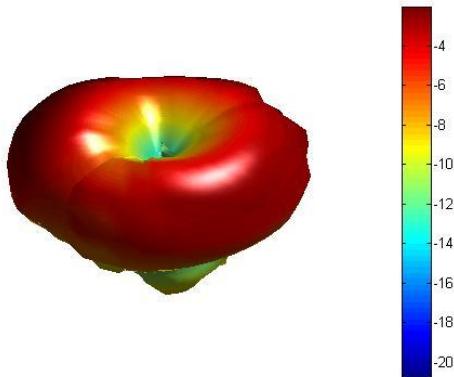

Freq = 0.8530GHz Az= 45 EL= 45

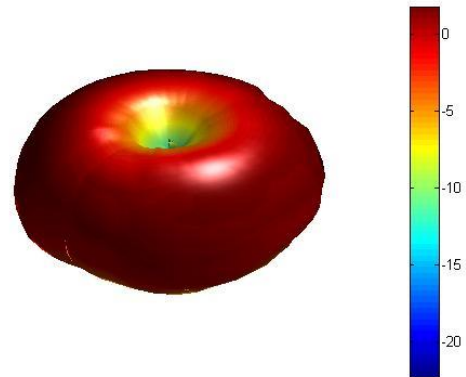

Freq = 0.897GHz Az= 45 EL= 45

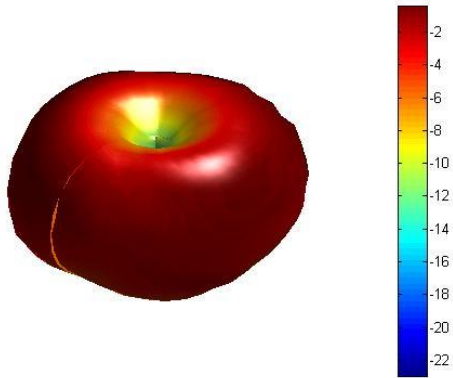

Freq = 1.799GHz Az= 45 EL= 45

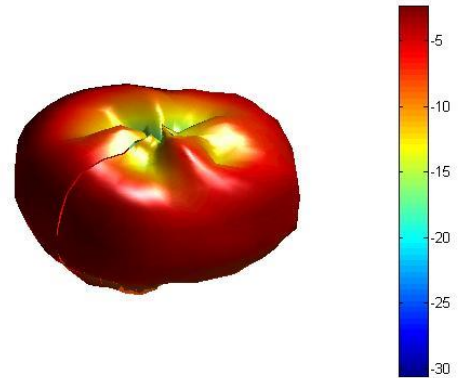

Freq = 1.898GHz Az= 45 EL= 45

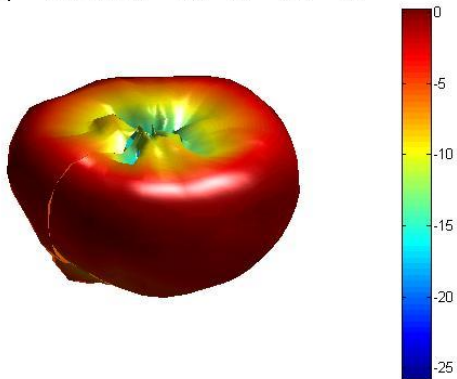

Freq = 2.107GHz Az= 45 EL= 45

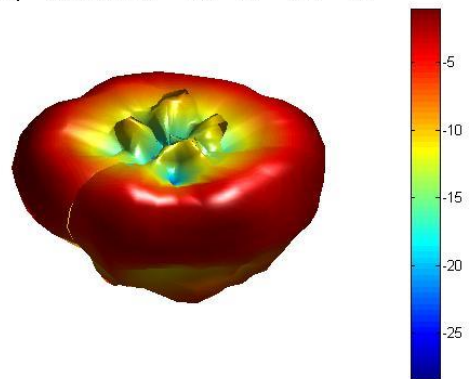

Freq = 2.404GHz Az= 45 EL= 45

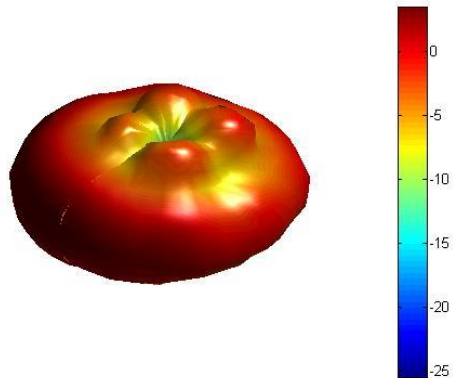

Freq = 2.602GHz Az= 45 EL= 45

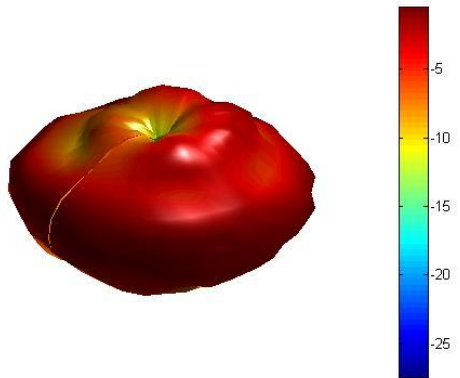

### 2.3. 2D Radiation pattern

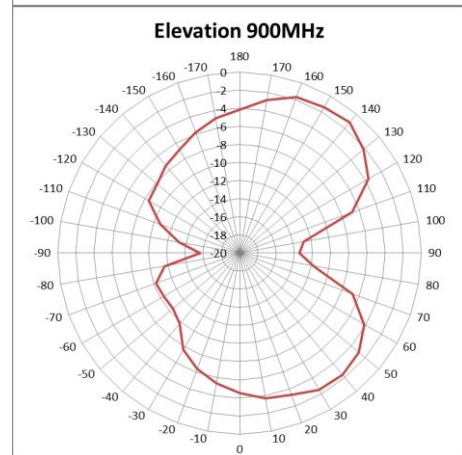
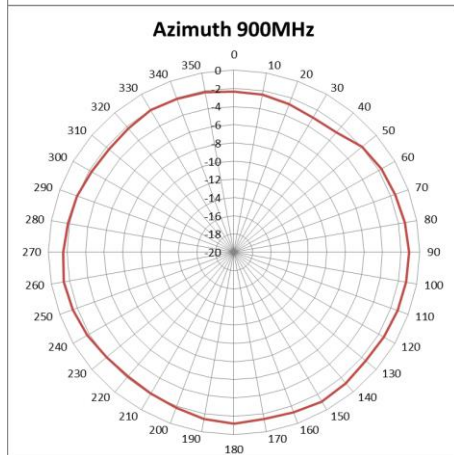
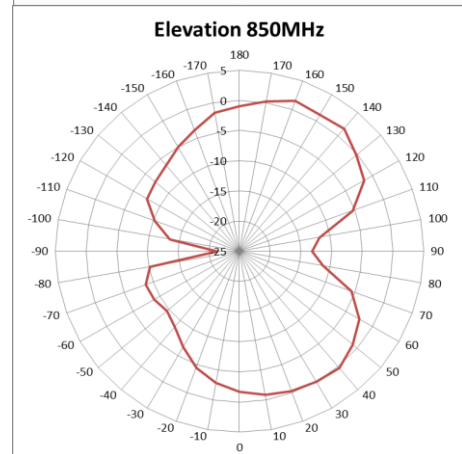
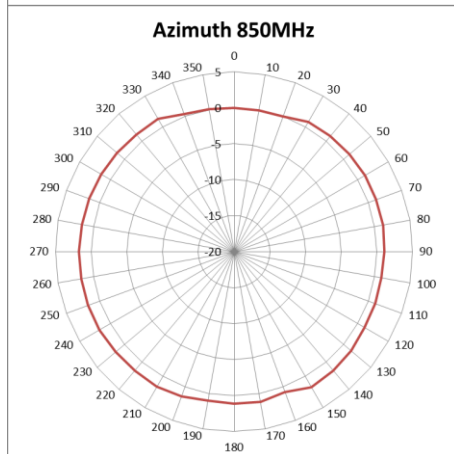
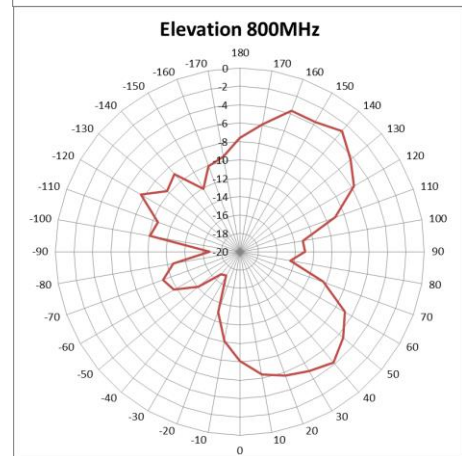
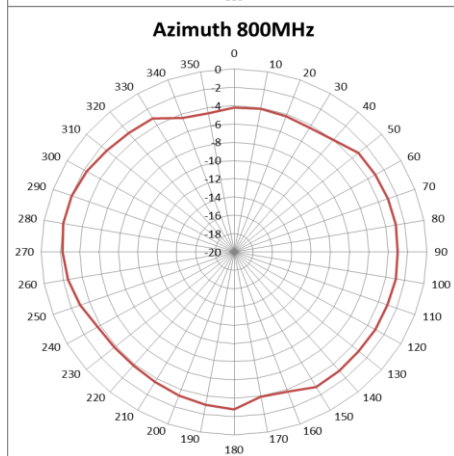
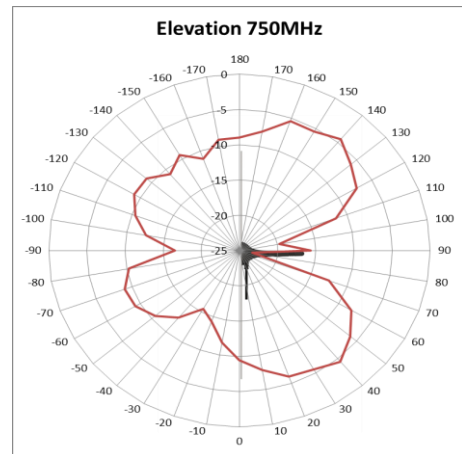
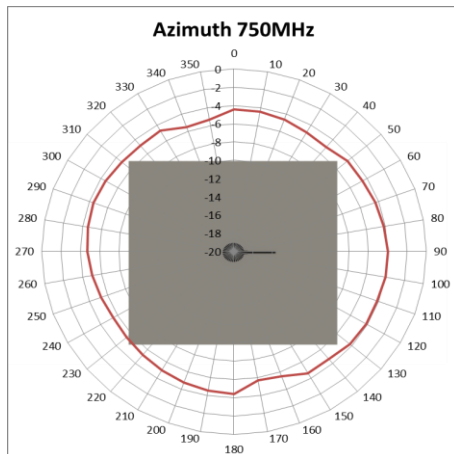

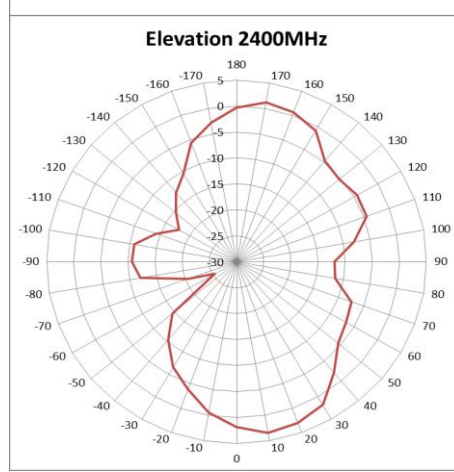
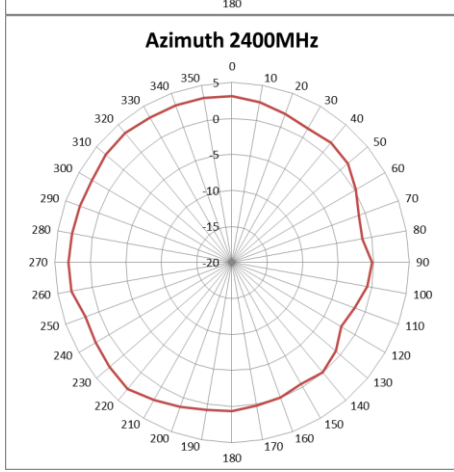
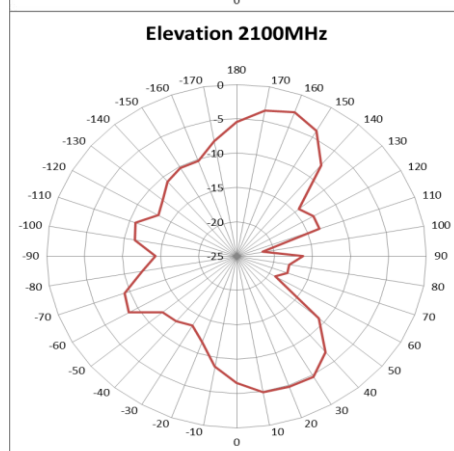
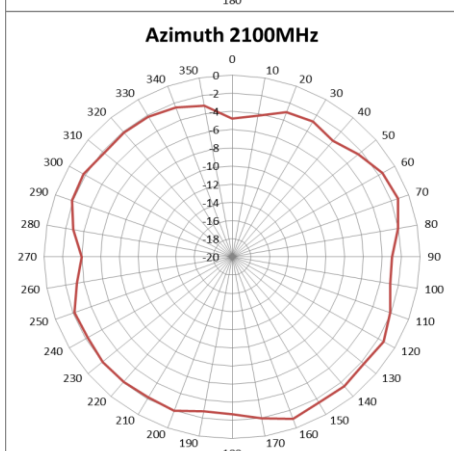
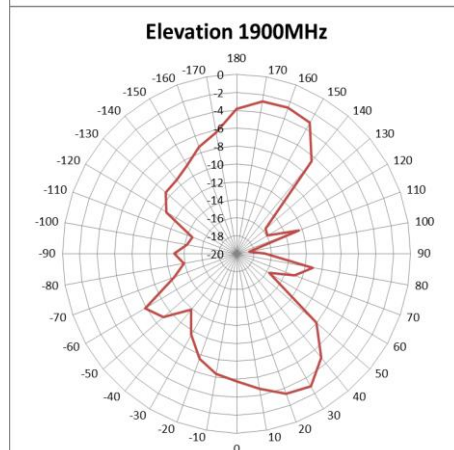
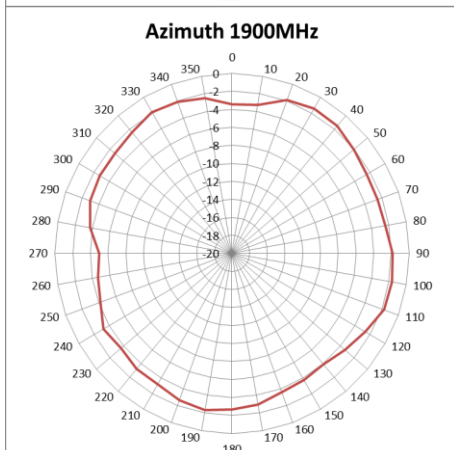
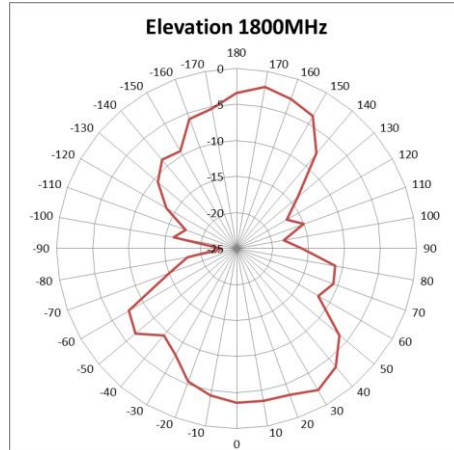
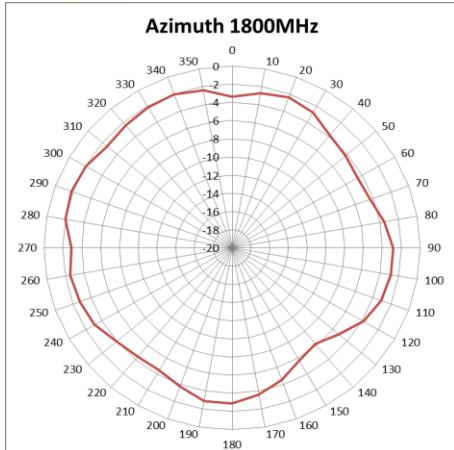

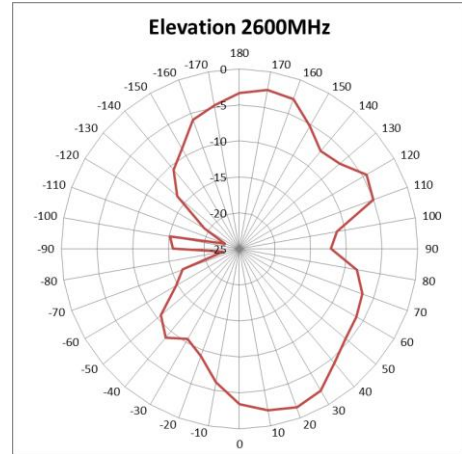
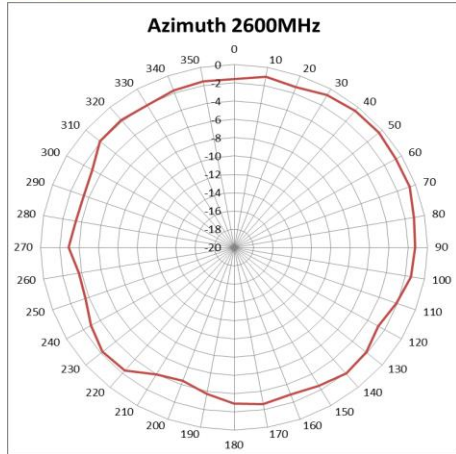

### 3. IMAGES

