

2J6506BG

Cellular, GNSS and 2.4 GHz ISM Screw Mount

Key Features

Cable 1: Cellular

- 824-960 MHz
- 1710-2170 MHz

Cable 2: 2.4 GHz ISM

- 2410-2490 MHz

Cable 3: GPS/GLONASS/QZSS/Galileo

- 1575-1610 MHz

Screw Mount

Anti-Rotation Mechanism

Ground Plane Dependent

Customizable Cable and Connector

Dimensions \varnothing 146 x 31.5 mm

Certificates: IK09, IP67, IP69K



1. Antenna and electrical specifications

Cable 1

Parameters	Cellular Antenna	
Standards	2G and 3G	
Band (MHz)	850/900	1700/1800/1900/2100
Frequency (MHz)	824-960	1710-2170
Return Loss (dB)	~-9.3	~-12.5
VSWR	~2.1:1	~1.7:1
Efficiency (%)	~43	~37
Peak Gain (dBi)	~1.8	~2.3
Average Gain (dB)	~-3.7	~-4.3
Impedance (Ohm)	50	
Polarisation	Linear	
Radiation Pattern	Omni-Directional	
Max. Input Power (W)	25	
Connector Type	SMA-Male Standard (Other Connectors Available)	
Cable Length	300 cm Standard (Any Cable Length Available)	
Cable Type	LMR100 Standard (Other Cables Available)	

Cable 2

Parameters	2.4 GHz ISM Antenna	
Standards	WiFi, BT, ZigBee, ISM	
Band (MHz)	2.4 GHz	
Frequency (MHz)	2410-2490	
Return Loss (dB)	~-15.5	
VSWR	~1.4:1	
Efficiency (%)	~38	
Peak Gain (dBi)	~2.5	
Average Gain (dB)	~-4.1	
Impedance (Ohm)	50	
Polarisation	Linear	
Radiation Pattern	Omni-Directional	
Max. Input Power (W)	10	
Connector Type	RP-SMA-Male Standard (Other Connectors Available)	
Cable Length	300 cm Standard (Any Cable Length Available)	
Cable Type	LMR100 Standard (Other Cables Available)	

Antenna Measurement Conditions:

Mounted on 30 x 30 cm Metal Plate

200 cm of LMR100 Cable

Measured in Certified CTIA 3D Anechoic Chamber

Cable 3

Parameters	GNSS Ceramic Active Antenna	
	GPS/QZSS/Galileo	GLONASS
Standards	GPS/QZSS/Galileo	GLONASS
Band (MHz)	1575	1602
Frequency (Mhz)	1575.42	1598-1606
Patch Size (mm)	25 x 25 x 4	
Passive Gain (dBi)	~3.6	
Impedance (Ohms)	50	
Radiation Pattern	Hemispherical	
Voltage Range (V)	1.5 – 3.6	
Active Gain (dB)	28 @ 2.7 V	
Noise Figure (dB)	1.8 @ 2.7 V	
Current Consumption (mA)	9 @ 2.7 V	
Power Consumption (mW)	24.3 @ 2.7V	
Saw Filter Type	Pre-Filter	
Out of Band Rejection (dBc)	~43	
ESD Protection (kV)	6	
Connector Type	SMA-Male Standard (Other Connectors Available)	
Cable Length	300 cm Standard (Any Cable Length Available)	
Cable Type	LMR100 Standard (Other Cables Available)	

2. Mechanical and environmental specifications

Specifications	2J6506BG
Mounting Type	Screw Mount
Dimensions (mm)	Ø 146 x 31.5
Radome	ABS
Radome color	Black
Antenna Base	Zamak
Gasket	TPE
Operating Temperature (C)	-40 to +85
Storage Temperature (C)	-40 to +85
Substance Compliance	RoHS
Certificates	IK09, IP67, IP69K

3. Antenna parameters

Table 1: Cellular

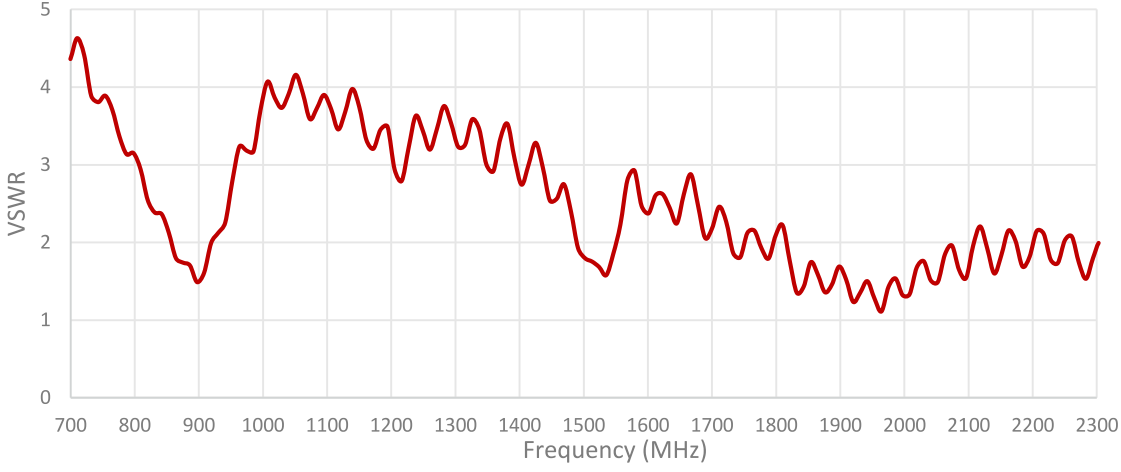
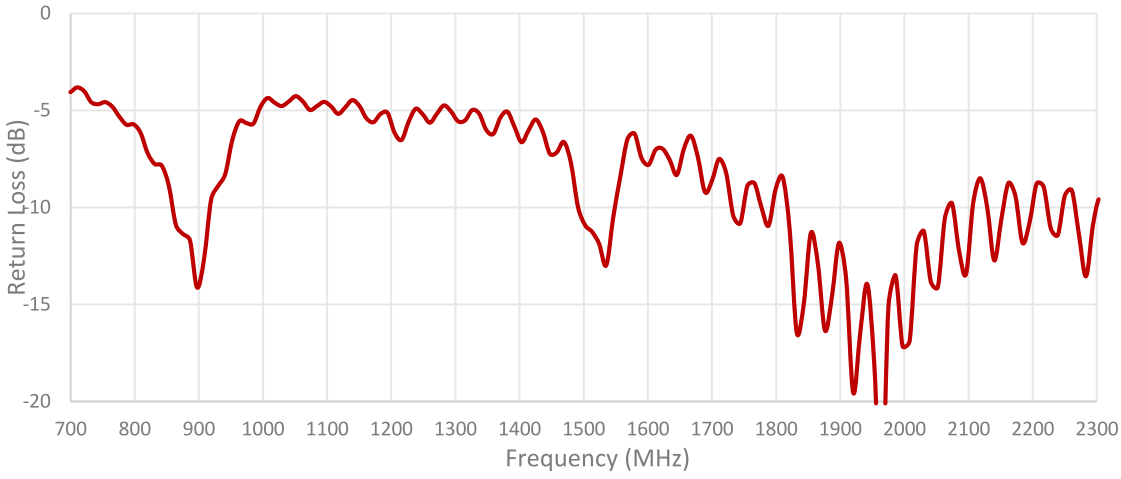

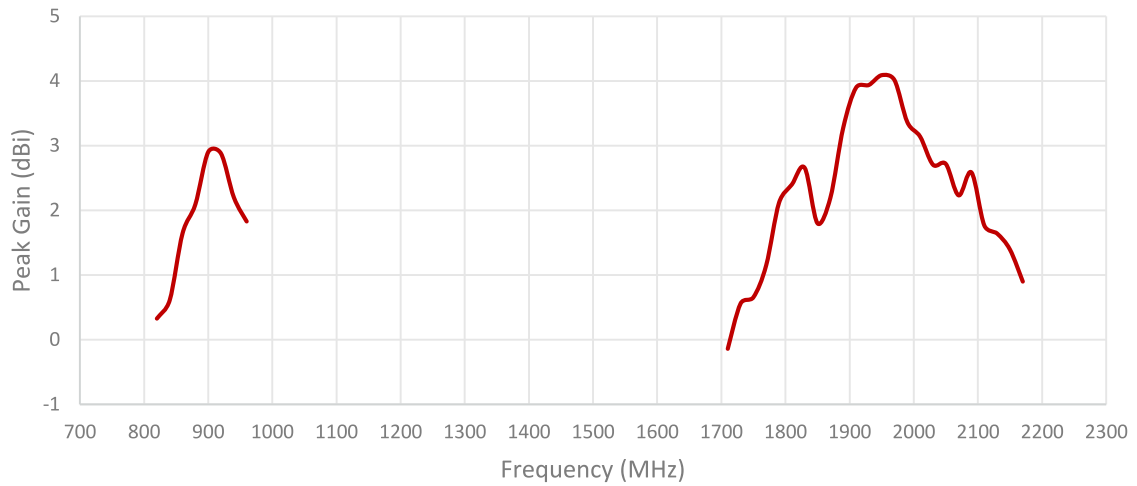
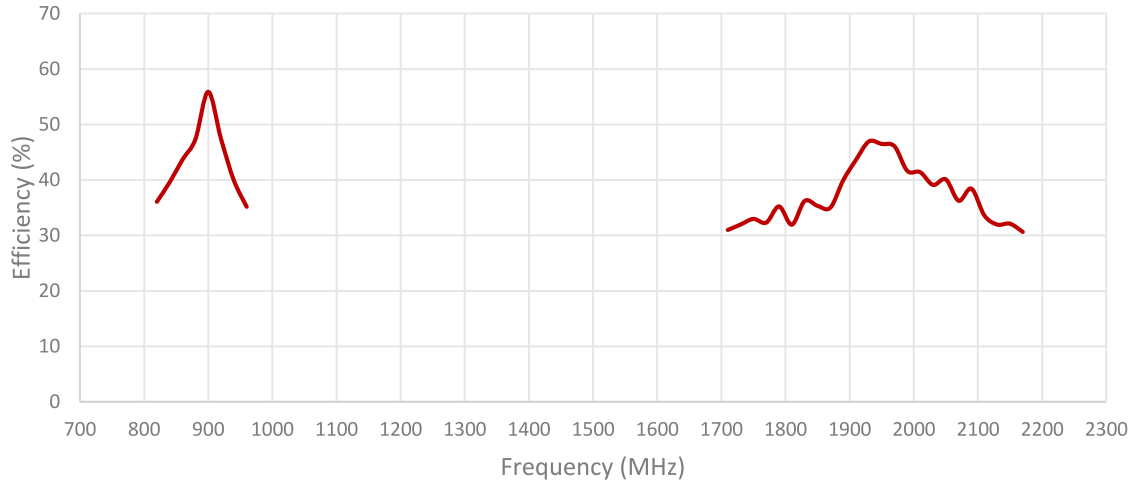

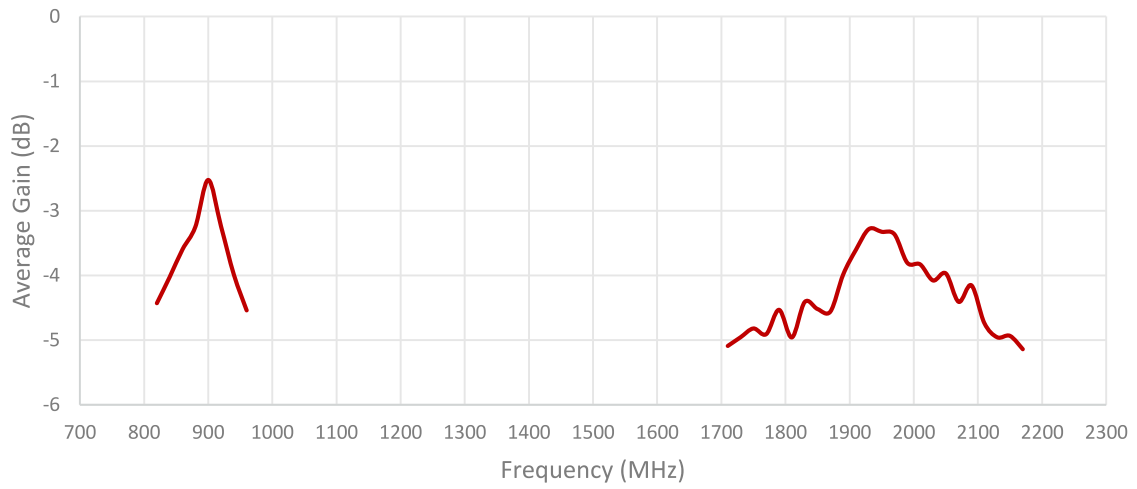
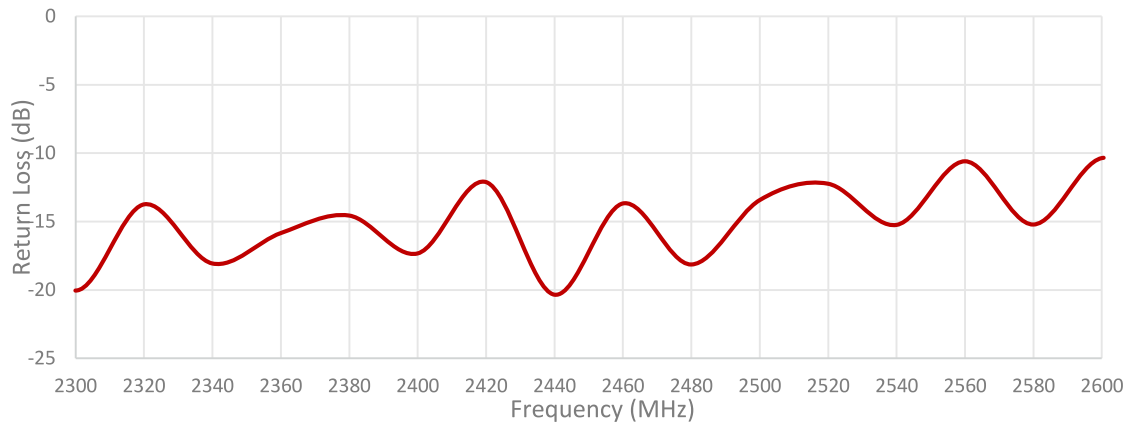
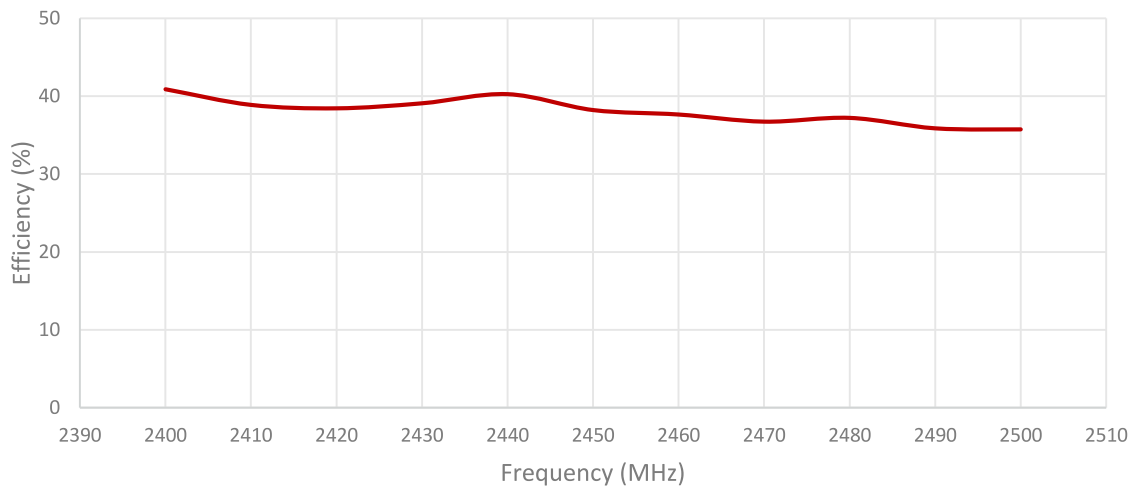
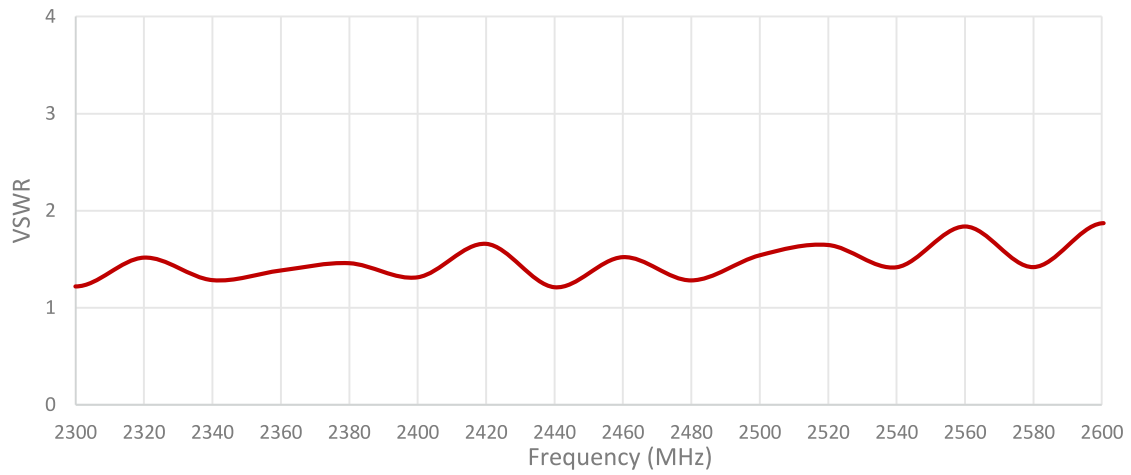
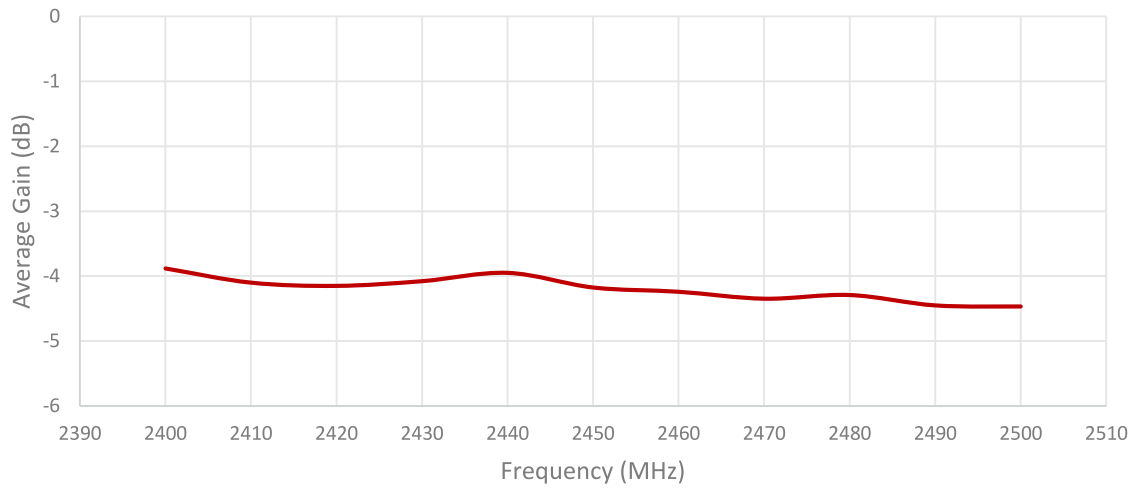
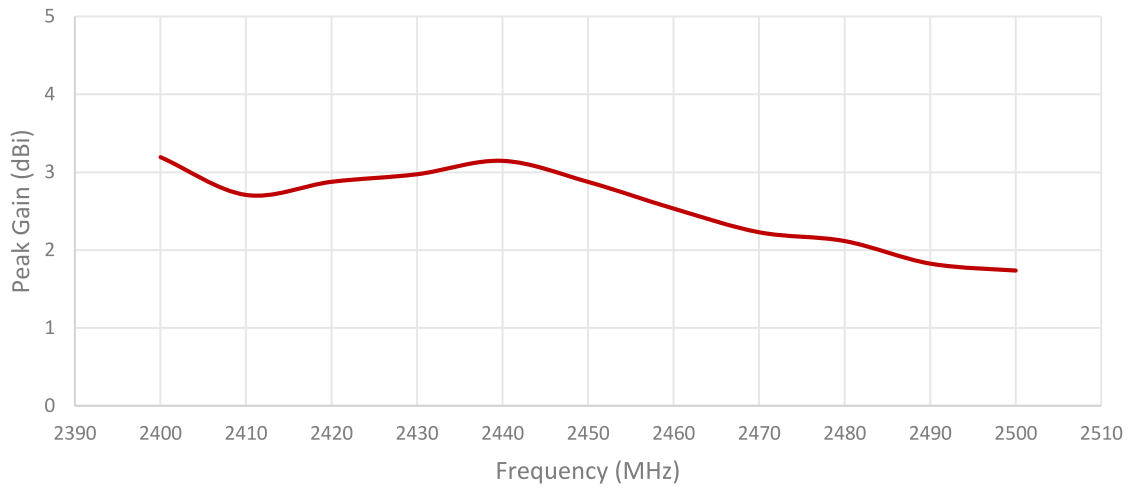
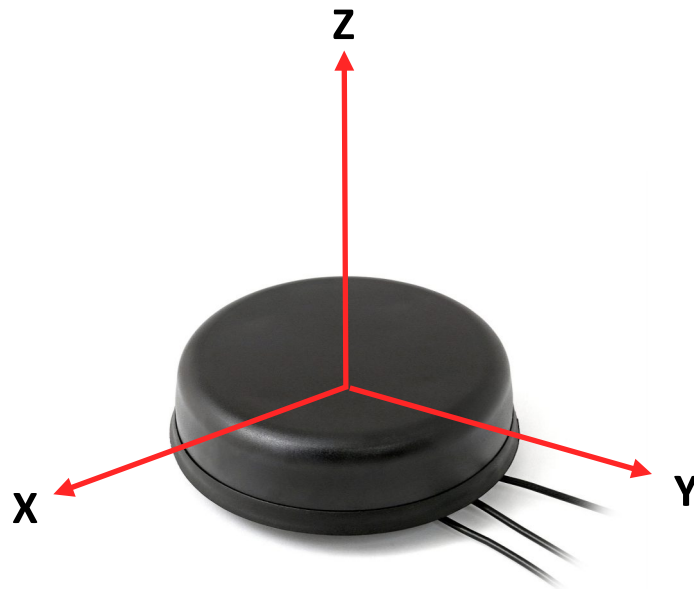

Table 2: 2.4 GHz ISM









Radiation pattern reference

Cable 1: Cellular

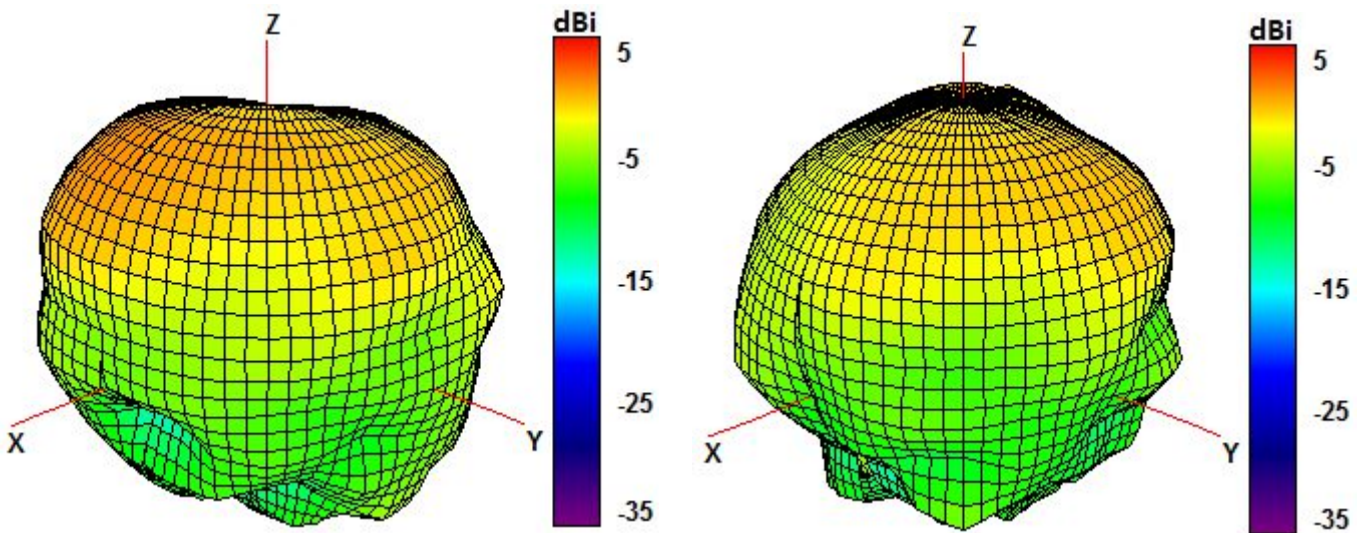

850 and 940 MHz Radiation pattern

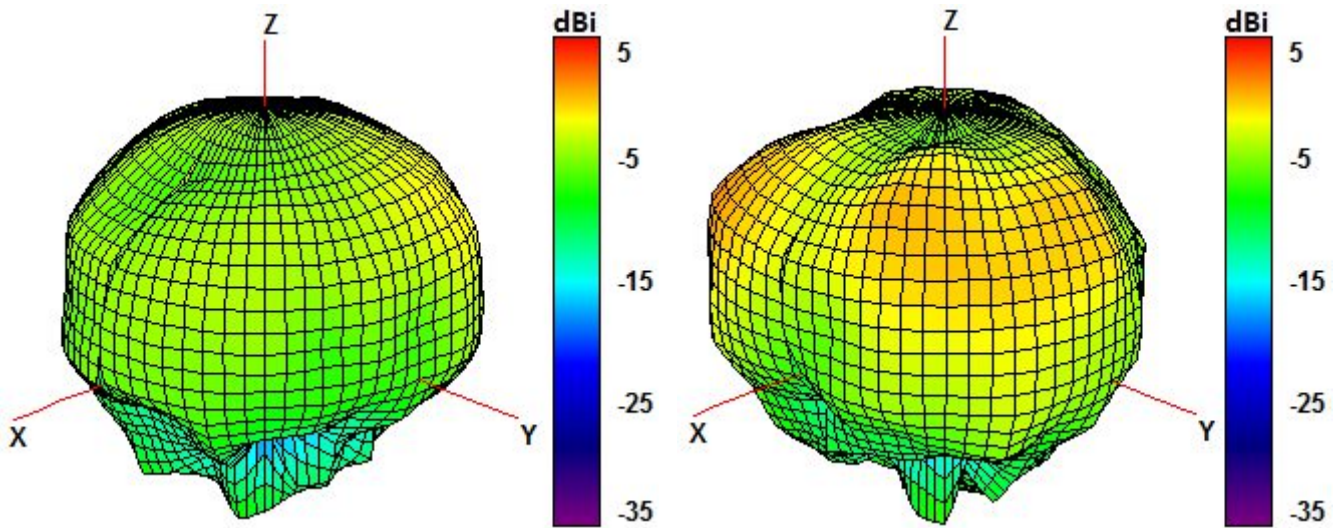

1750 and 1850 MHz Radiation pattern

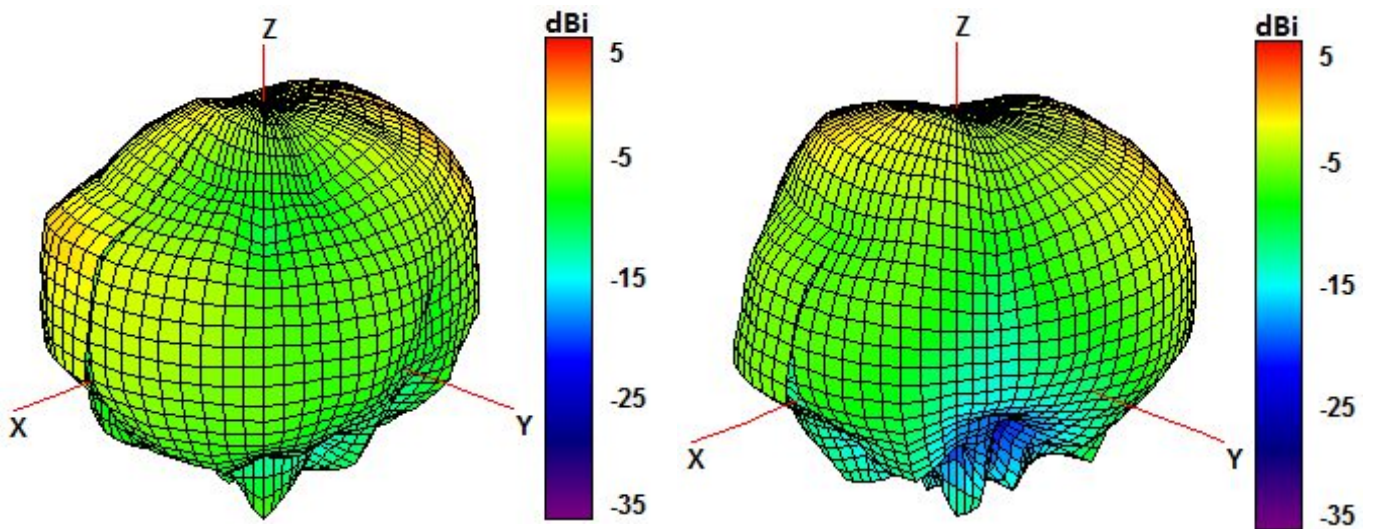

1950 and 2100 MHz Radiation pattern

Cable 2: 2.4 GHz ISM

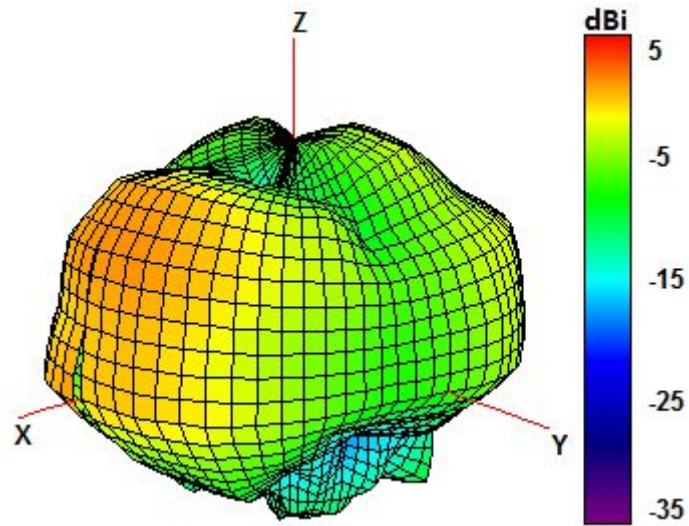

2450 MHz Radiation pattern

4. Antenna drawings

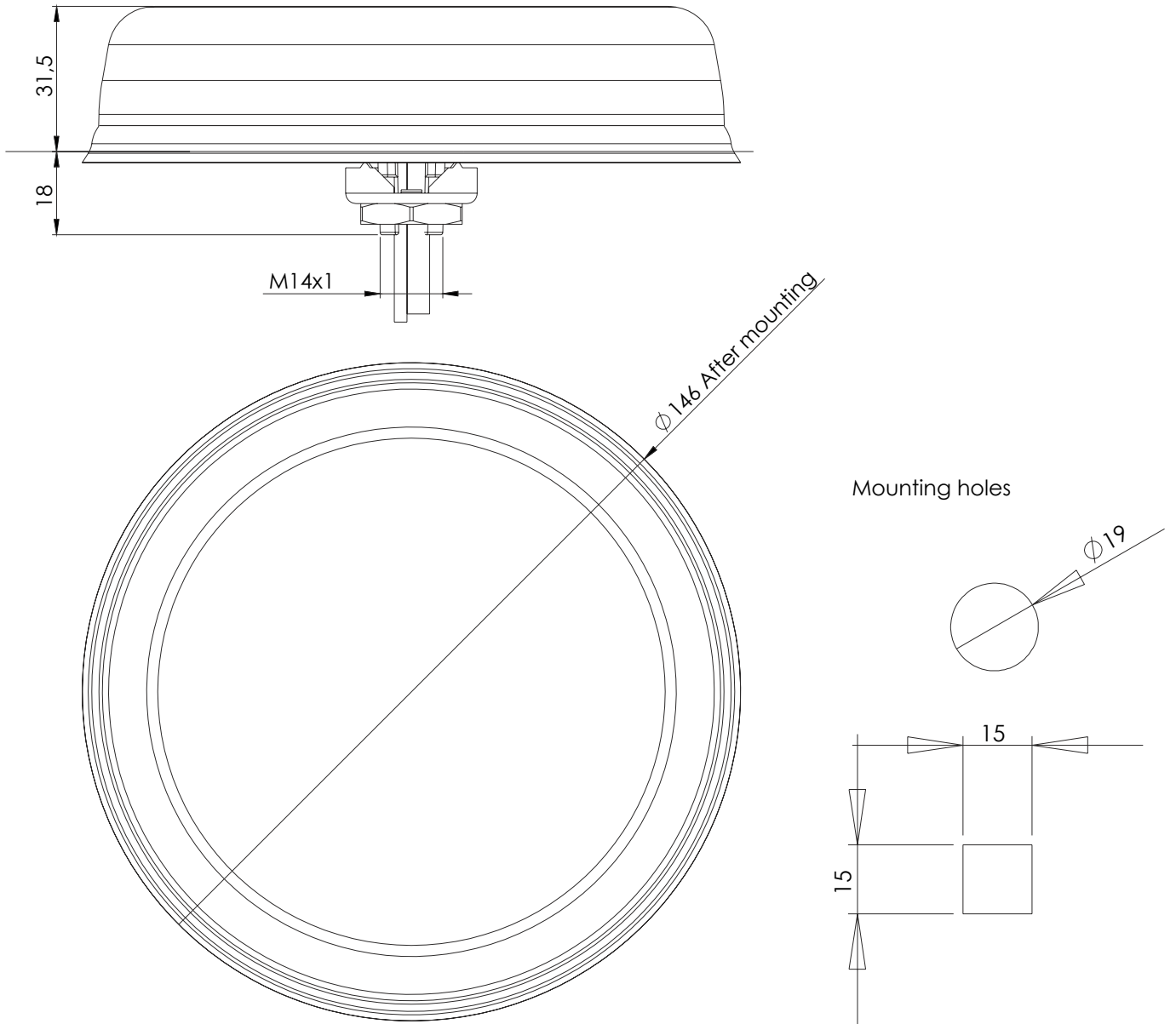

5. Antenna Images

