

2J7050BGa

CELLULAR/LTE MIMO, 2.4/5.0 GHz ISM MIMO and GNSS

Key Features

Cable 1 and 2: CELLULAR / LTE

Cable 3 and 4: 2.4/5.0 GHz ISM

Cable 5: GPS/GLONASS/QZSS/Galileo

Screw Mount

Heavy Duty antenna

High Performance

Ground Plane Independent

Anti-Rotation Mounting

Customizable Cable and Connector

Dimensions: Ø 96 x H 90 mm

Certificates: IP67, IP69, IK09



Description

Compact heavy duty antenna designed for 4G LTE, 2.4/5.0 GHz ISM and GNSS suitable for wide range of applications within industry. Antenna is made with specific anti-rotation mounting system. Housing of the antenna is certified for standards of IP67 for water resistance, IK09 for high impact resistance and IP69K standard for high pressure and hot water ingress.



1. Antenna and electrical specifications

Cable 1

Parameters	CELLULAR / LTE Antenna		
Standards	2G,3G and 4G		
Band (MHz)	700/850/900	1700/1800/1900/2100	2600
Frequency (MHz)	698-960	1710-2170	2500-2700
Return Loss (dB)	~-10.6	~-15.6	~-11.7
VSWR	~1.9:1	~1.6:1	~1.7:1
Efficiency (%)	~57	~57	~47
Peak Gain (dBi)	~-2.1	~-4.2	~-3.1
Average Gain (dB)	~-2.4	~-2.5	~-3.3
Impedance (Ohm)	50		
Polarisation	Linear		
Radiation Pattern	Omni-Directional		
Max. Input Power (W)	25		
Connector Type	Most RF Connectors (SMA-Male Standard)		
Cable Length	Any Cable Length (300 cm Standard)		
Cable Type	Other Cables Available (LMR195 Standard)		

Cable 2

Parameters	CELLULAR / LTE Antenna		
Standards	2G,3G and 4G		
Band (MHz)	700/850/900	1700/1800/1900/2100	2600
Frequency (MHz)	698-960	1710-2170	2500-2700
Return Loss (dB)	~-11.0	~-14.3	~-16.5
VSWR	~1.9:1	~1.6:1	~1.4:1
Efficiency (%)	~63	~54	~57
Peak Gain (dBi)	~-3.0	~-3.2	~-4.0
Average Gain (dB)	~-2.0	~-2.6	~-2.4
Impedance (Ohm)	50		
Polarisation	Linear		
Radiation Pattern	Omni-Directional		
Max. Input Power (W)	25		
Connector Type	Most RF Connectors (SMA-Male Standard)		
Cable Length	Any Cable Length (300 cm Standard)		
Cable Type	Other Cables Available (LMR195 Standard)		

Antenna Measurement Conditions:

Mounted on Metal Plate of 30 x 30 cm
 200 cm of LMR195 Cable
 Measured in Certified CTIA 3D Anechoic Chamber

Cable 3

Parameters	2.4/5.0 GHz ISM Antenna	
Standards	WiFi, BT, ZigBee, ISM	
Band (MHz)	2.4 GHz	5.0 GHz
Frequency (MHz)	2410-2490	4920-5925
Return Loss (dB)	~-10.4	~-13.6
VSWR	~1.9:1	~1.6:1
Efficiency (%)	~58	~64
Peak Gain (dBi)	~5.6	~5.5
Average Gain (dB)	~-2.3	~-1.9
Impedance (Ohm)	50	
Polarisation	Linear	
Radiation Pattern	Omni-Directional	
Max. Input Power (W)	25	
Connector Type	Most RF Connectors (SMA-Male Standard)	
Cable Length	Any Cable Length (300 cm Standard)	
Cable Type	Other Cables Available (LMR195 Standard)	

Cable 4

Parameters	2.4/5.0 GHz ISM Antenna	
Standards	WiFi, BT, ZigBee, ISM	
Band (MHz)	2.4 GHz	5.0 GHz
Frequency (MHz)	2410-2490	4920-5925
Return Loss (dB)	~-8.9	~-13.6
VSWR	~2.1:1	~1.6:1
Efficiency (%)	~57	~59
Peak Gain (dBi)	~5.5	~4.4
Average Gain (dB)	~-2.4	~-2.3
Impedance (Ohm)	50	
Polarisation	Linear	
Radiation Pattern	Omni-Directional	
Max. Input Power (W)	25	
Connector Type	Most RF Connectors (SMA-Male Standard)	
Cable Length	Any Cable Length (300 cm Standard)	
Cable Type	Other Cables Available (LMR195 Standard)	

Antenna Measurement Conditions:

Mounted on Metal Plate of 30 x 30 cm
 200 cm of LMR195 Cable
 Measured in Certified CTIA 3D Anechoic Chamber

Cable 5

Parameters	GPS/GLONASS Antenna	
	GPS/QZSS/Galileo	GLONASS
Standard		
Band (MHz)	1575	1602
Frequency(MHz)	1575.42	1598-1610
Return Loss (dB)	<=-14	
VSWR	<=1.5:1	
Impedance	50	
Radiation Pattern	Hemispherical	
Polarization	RHCP	
Saw Filter	Pre-Filter	
Active Gain (dB)	28 @ 2.7 V	
Noise Figure (dB)	1.8 @ 2.7 V	
Voltage (V)	1.5 – 3.6	
Current Consumption (mA)	9 @ 2.7 V	
Power Consumption (mW)	24.3 @ 2.7 V	
Out of Band Rejection (dBc)	~43	
ESD Protection (kV)	6	
Connector Type	SMA-Male Standard (Other Connectors Available)	
Cable Length	300 cm Standard (Any Cable Length Available)	
Cable Type	LMR100 Standard (Other Cables Available)	

2. Mechanical and environmental specifications

Specifications	2J7050BGa
Mounting Type	Screw Mount
Dimensions (mm)	Ø 96 x H 90
Radome	ASA
Radome color	White, Black
Antenna Base	Alluminium alloy
Operating Temperature (C)	-40 to +85
Storage Temperature (C)	-40 to +85
Substance Compliance	RoHS
Certificates	IP67, IP69, IK09

3. Antenna parameters

Cable 1: CELLULAR/LTE

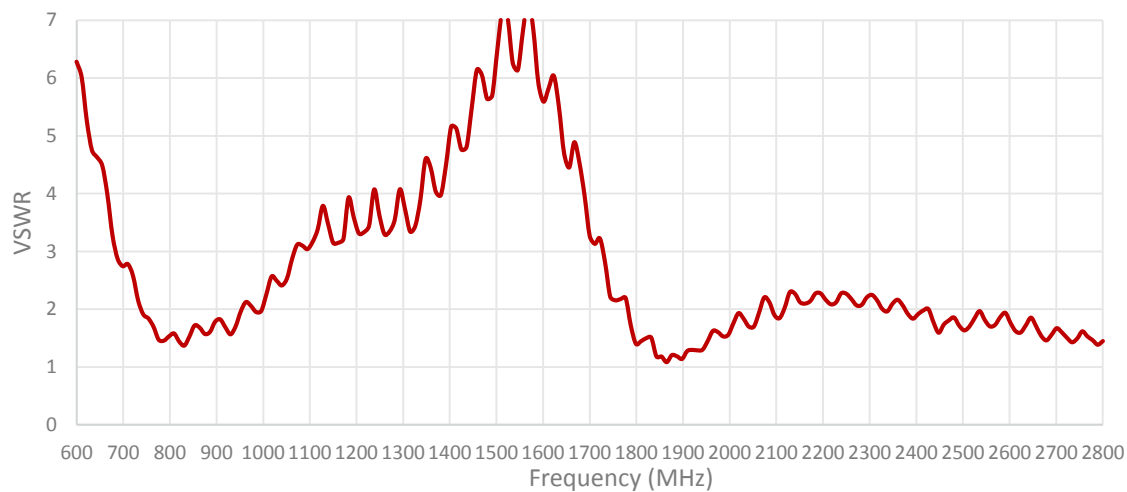
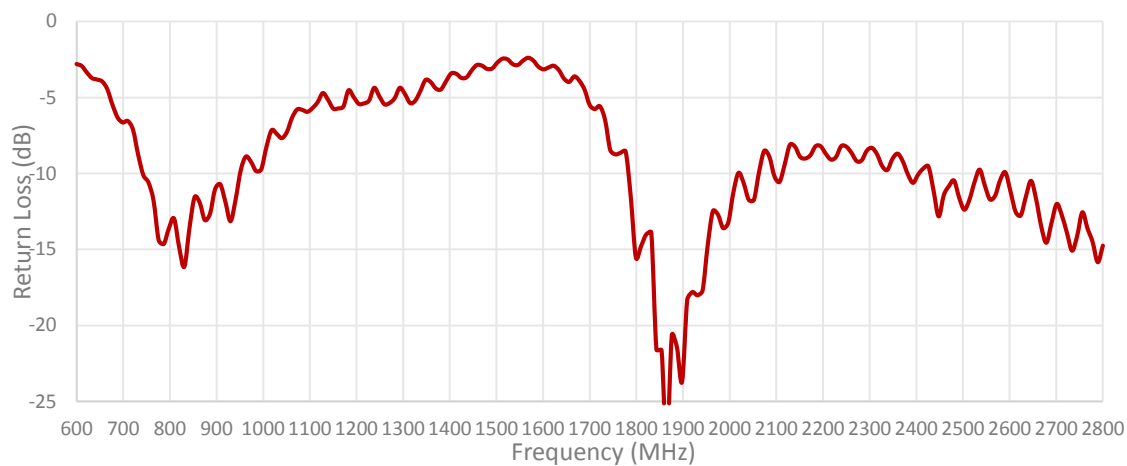

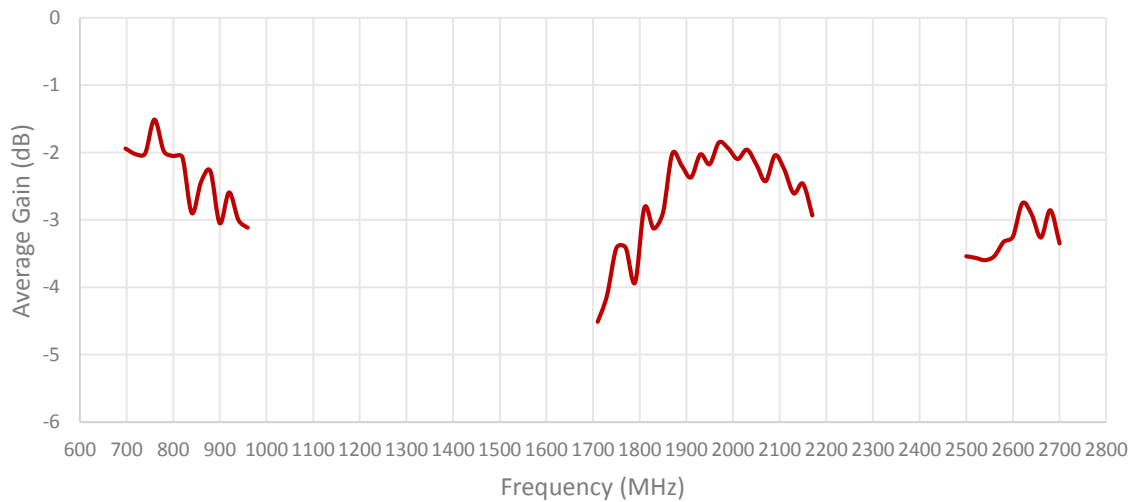
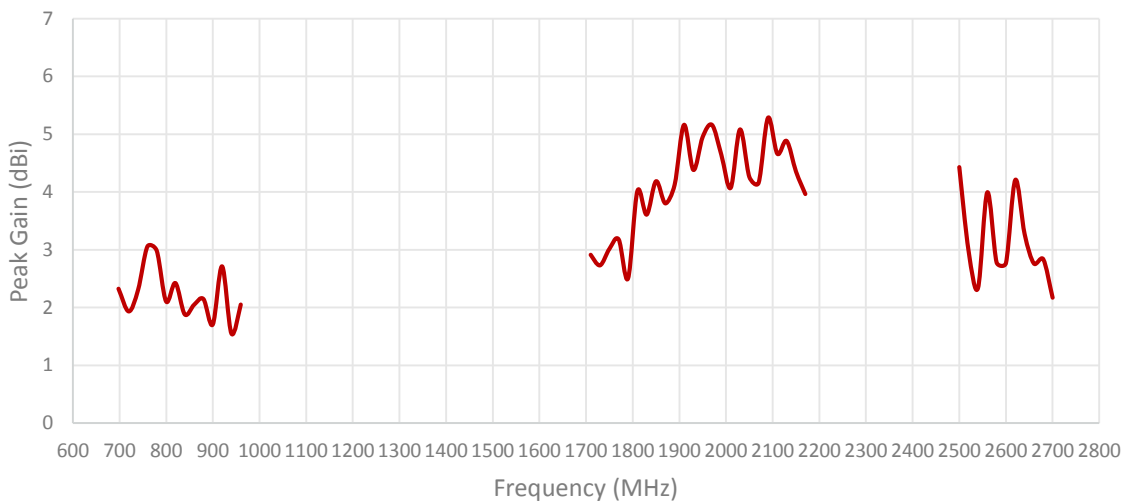
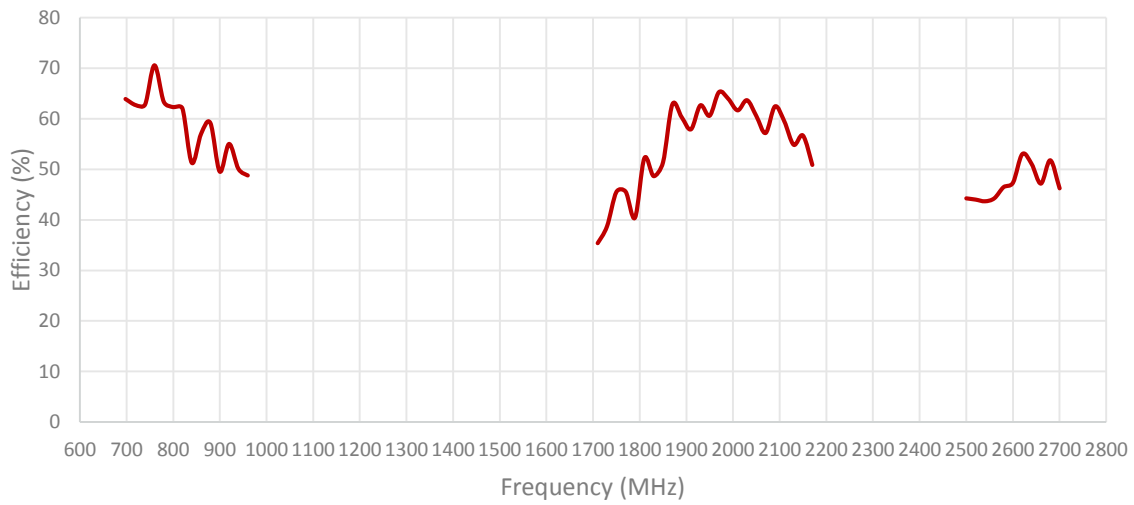
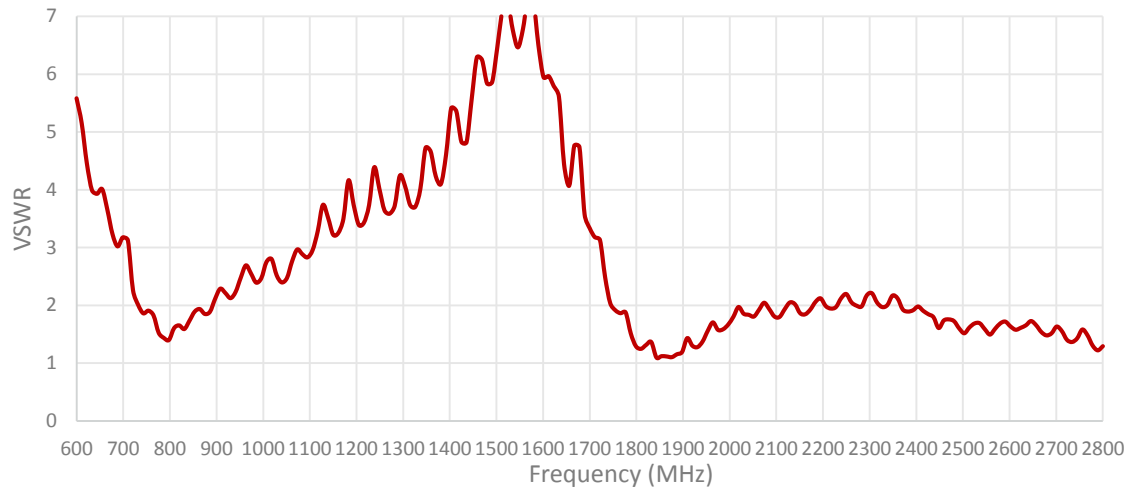
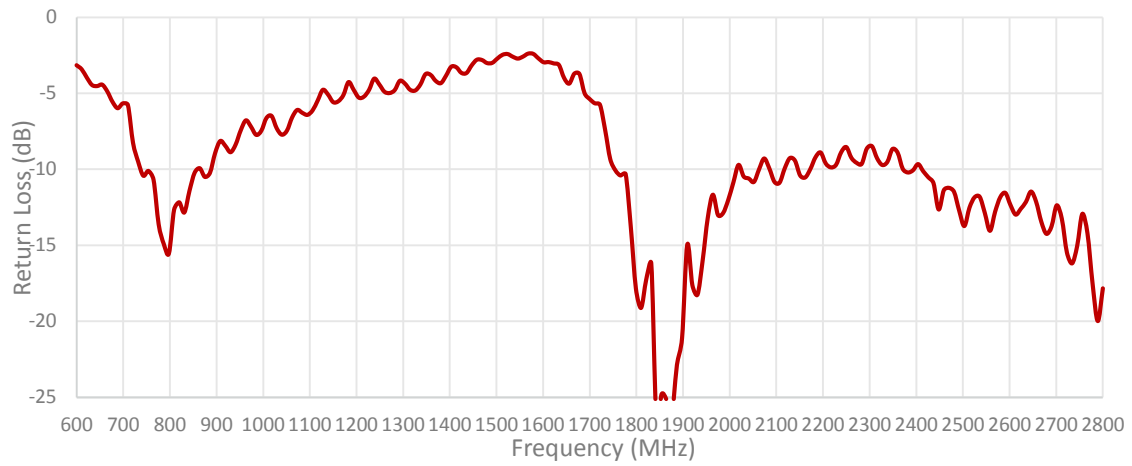
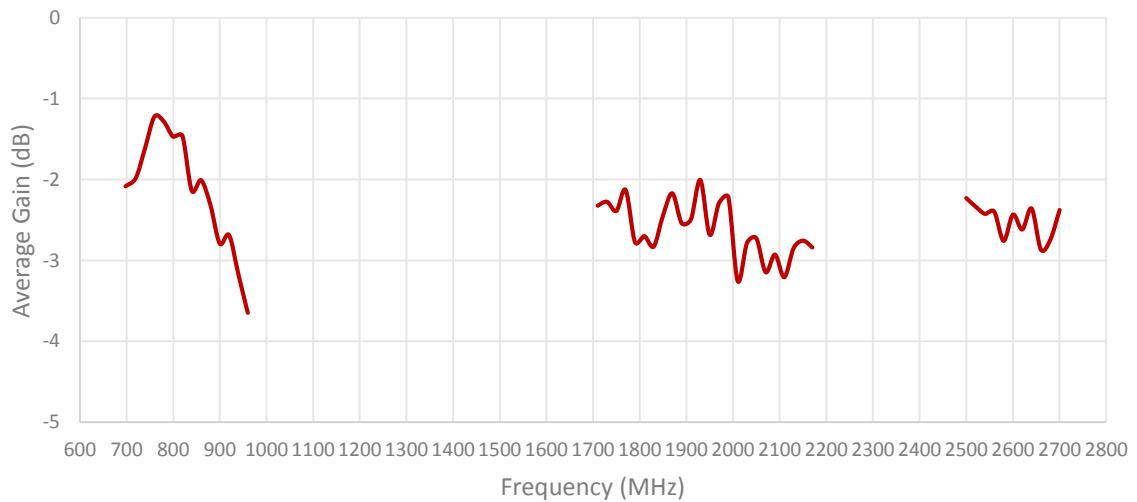
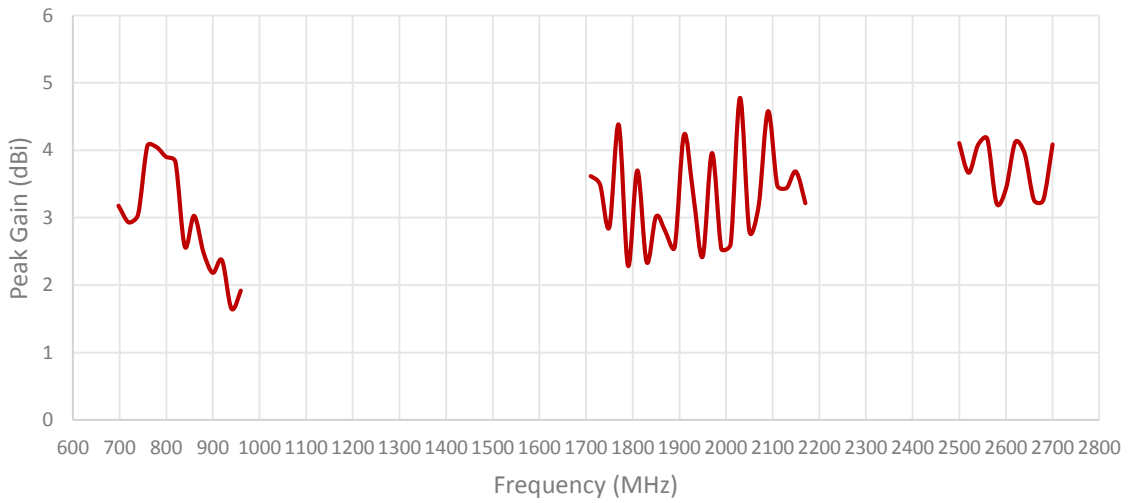
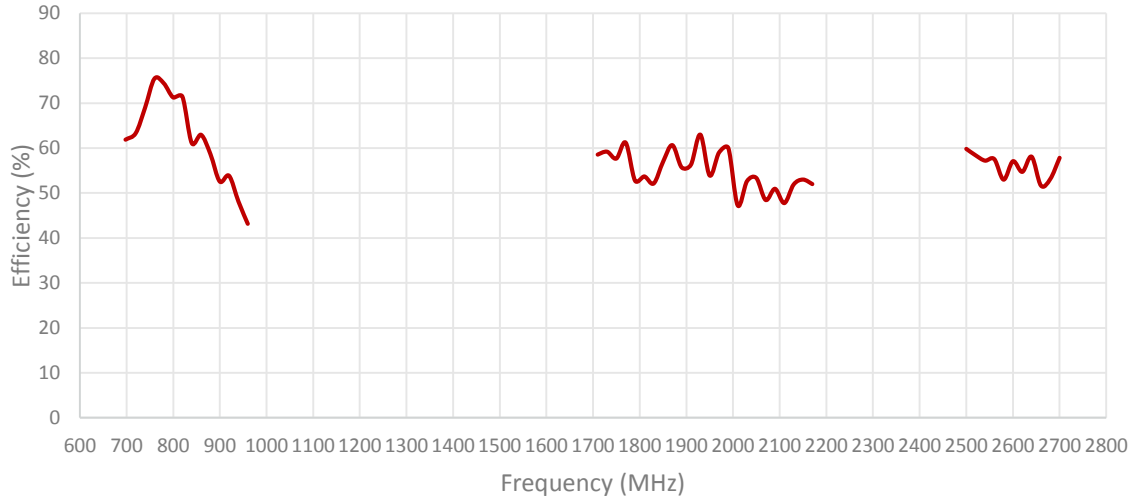
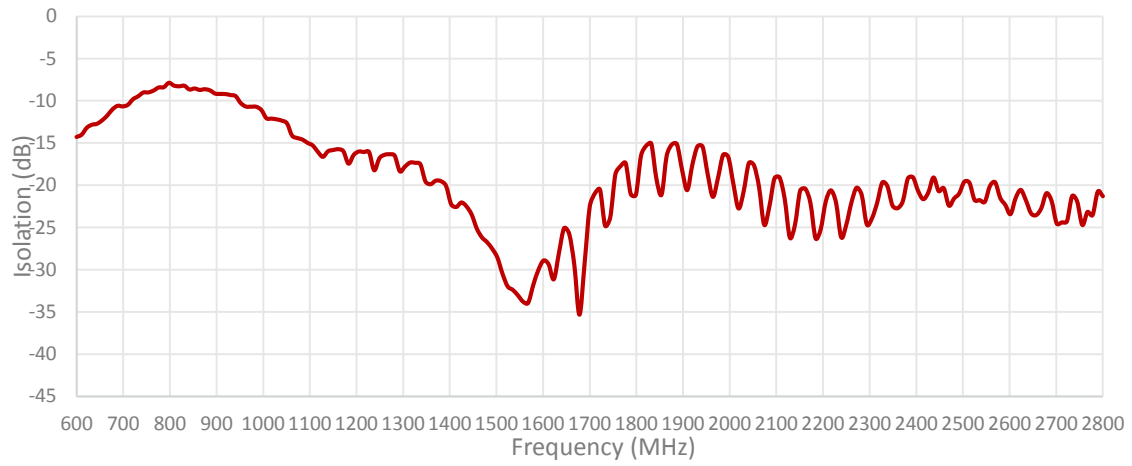

Table 2: CELLULAR/LTE





ISOLATION FOR CABLES 1 AND 2



ENVELOPE CORRELATION COEFFICIENT FOR CABLES 1 AND 2

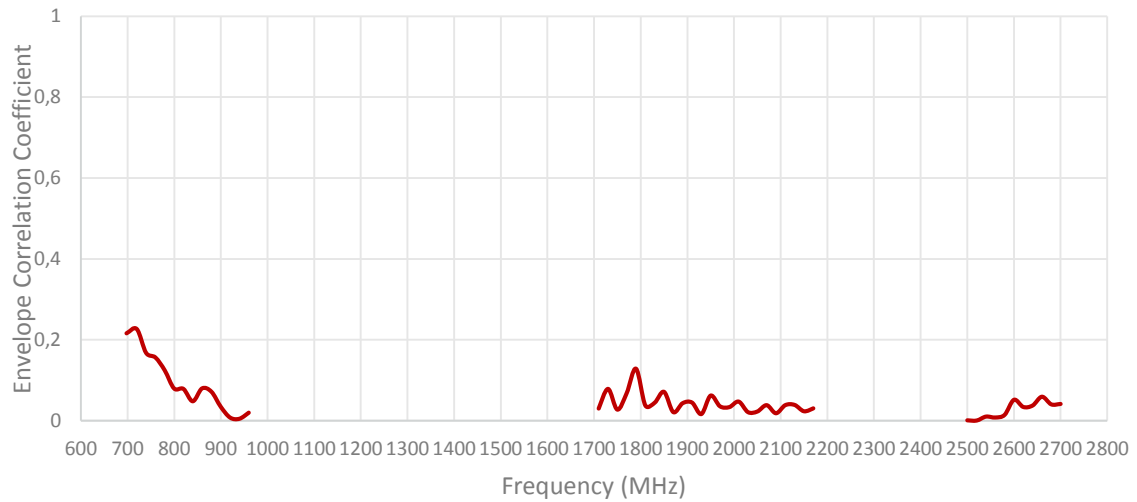

Cable 3: 2.4/5.0 GHz ISM

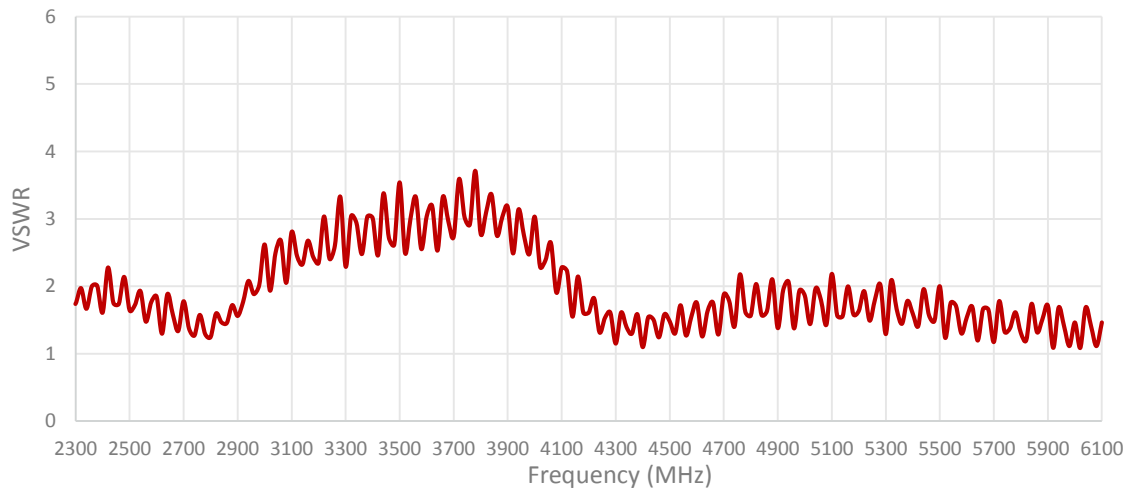
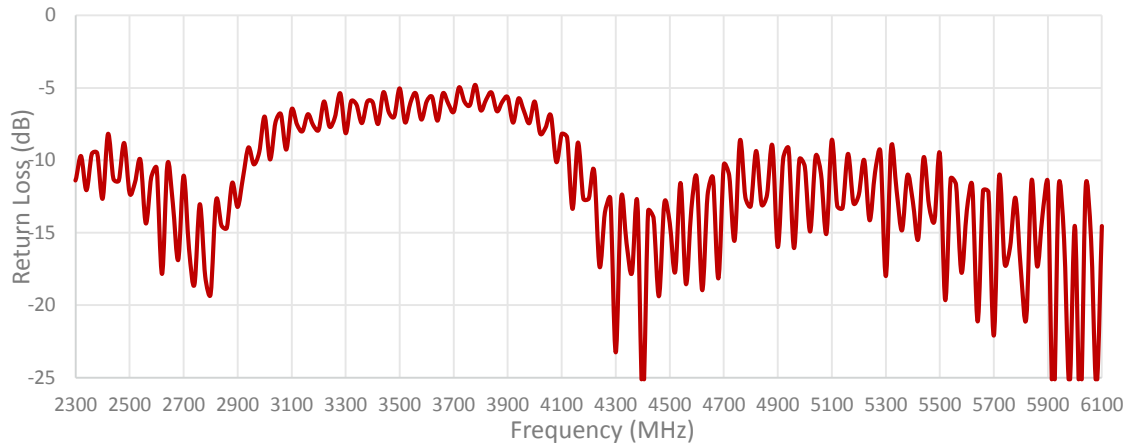

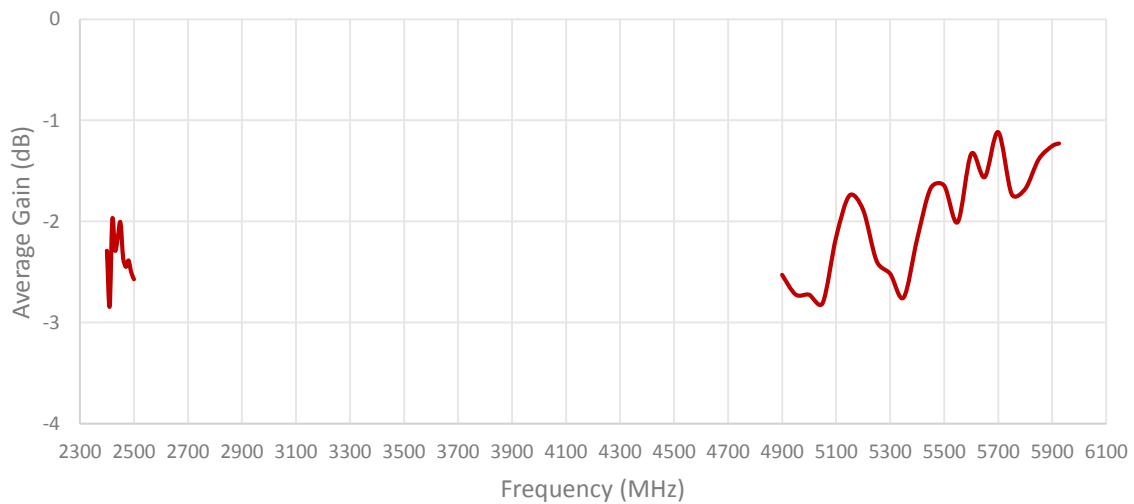
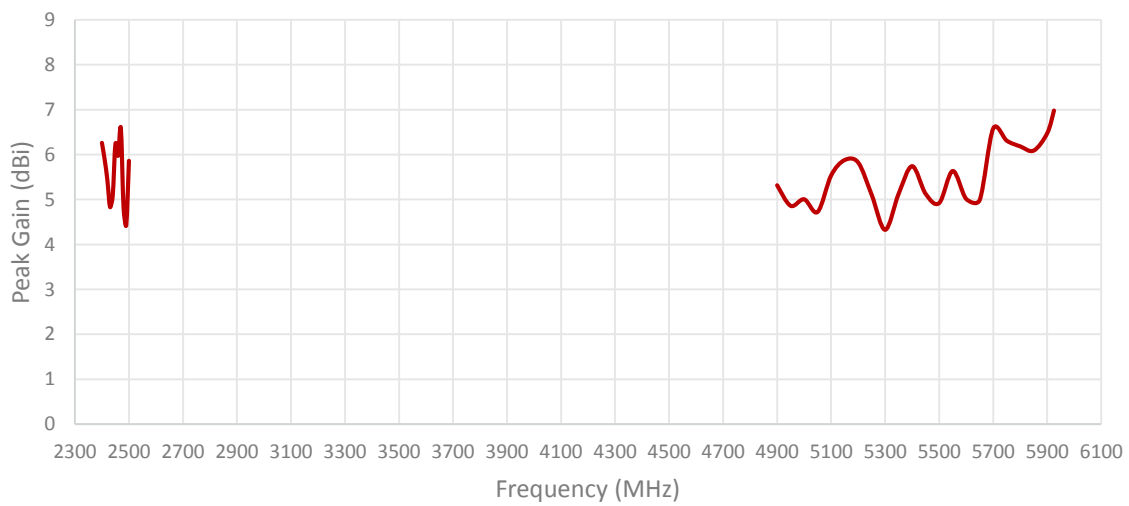
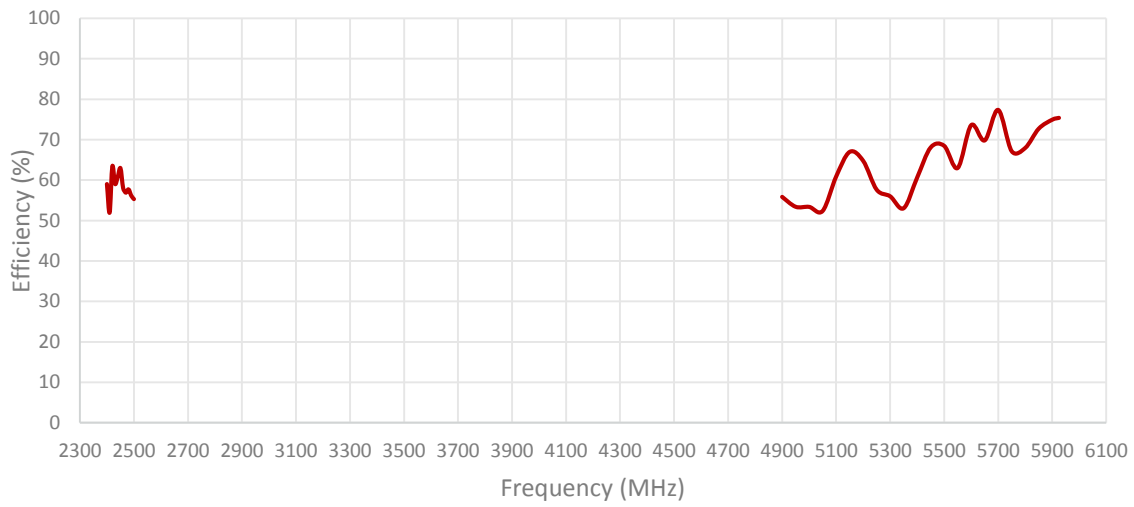
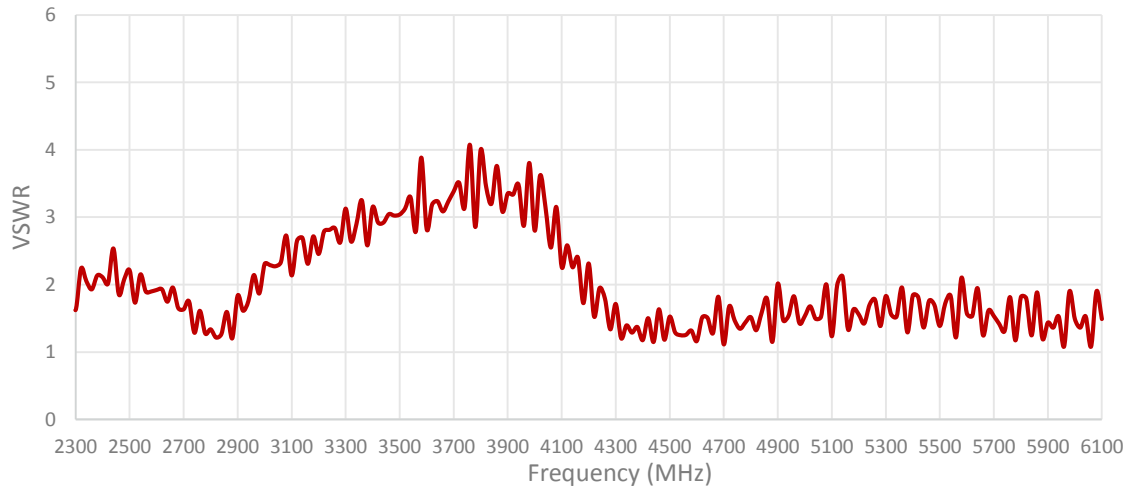
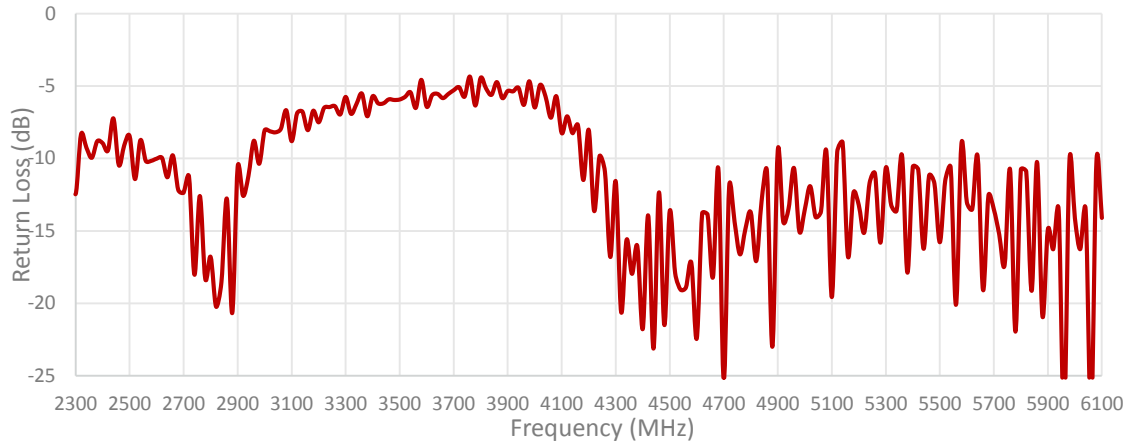
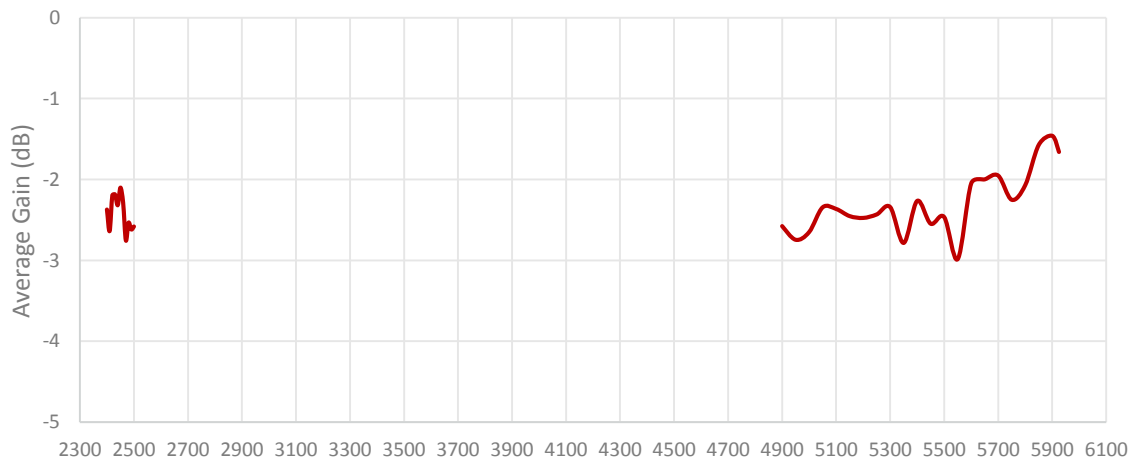
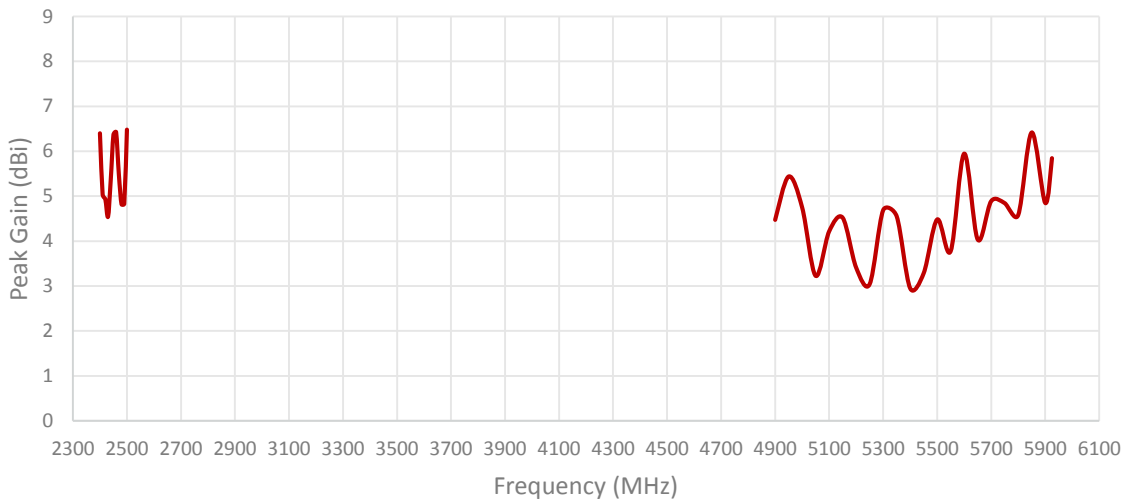
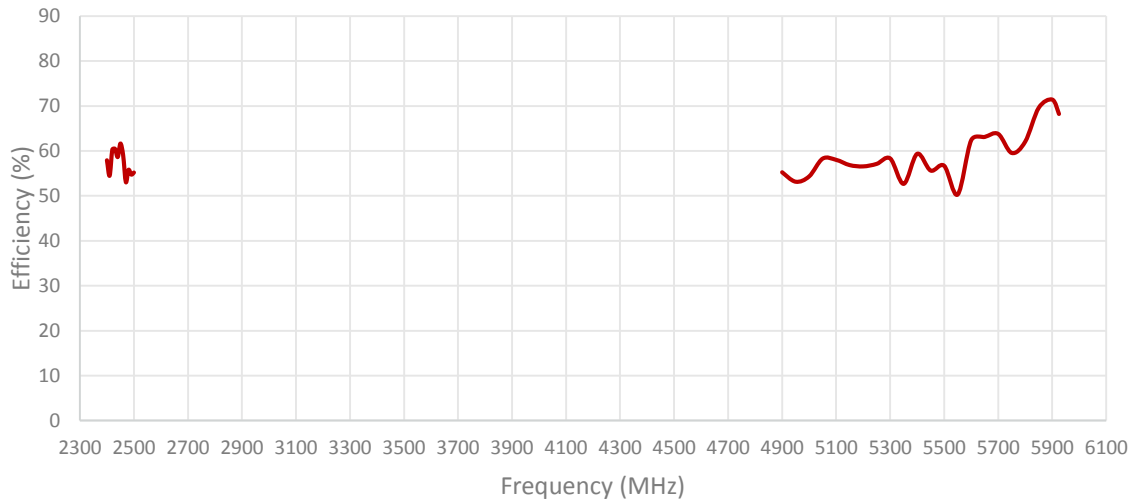
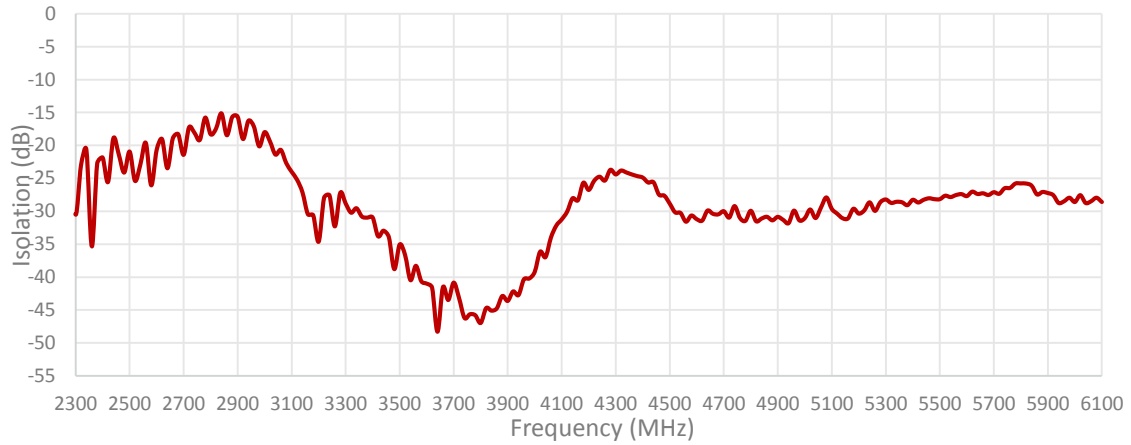

Table 4: 2.4/5.0 GHz ISM





ISOLATION FOR CABLES 3 AND 4



ENVELOPE CORRELATION COEFFICIENT FOR CABLES 3 AND 4

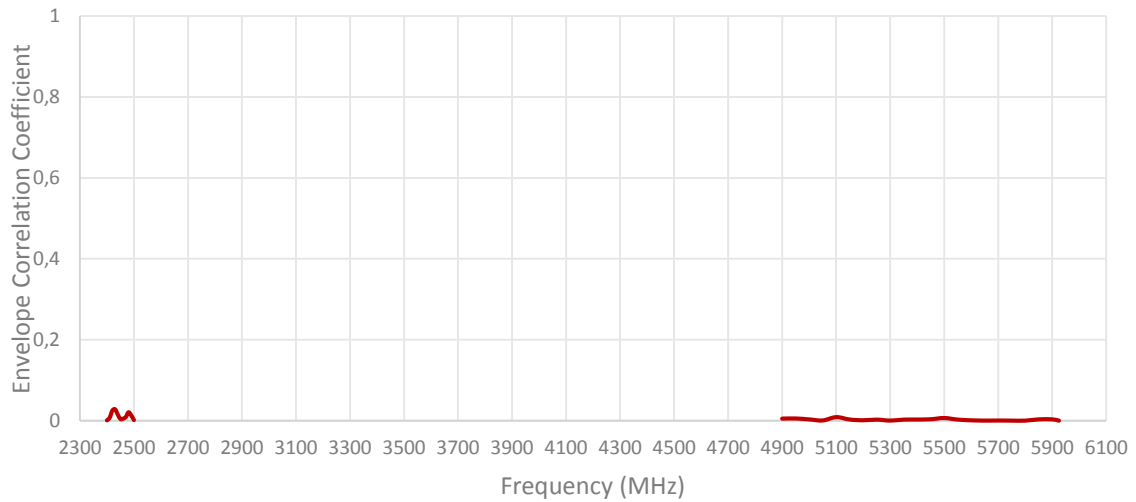

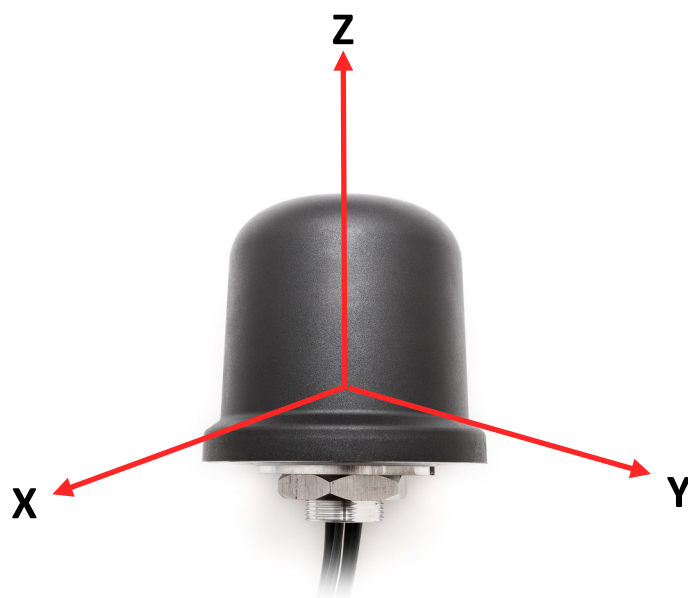

Radiation pattern reference

Cable 1: CELLULAR/LTE

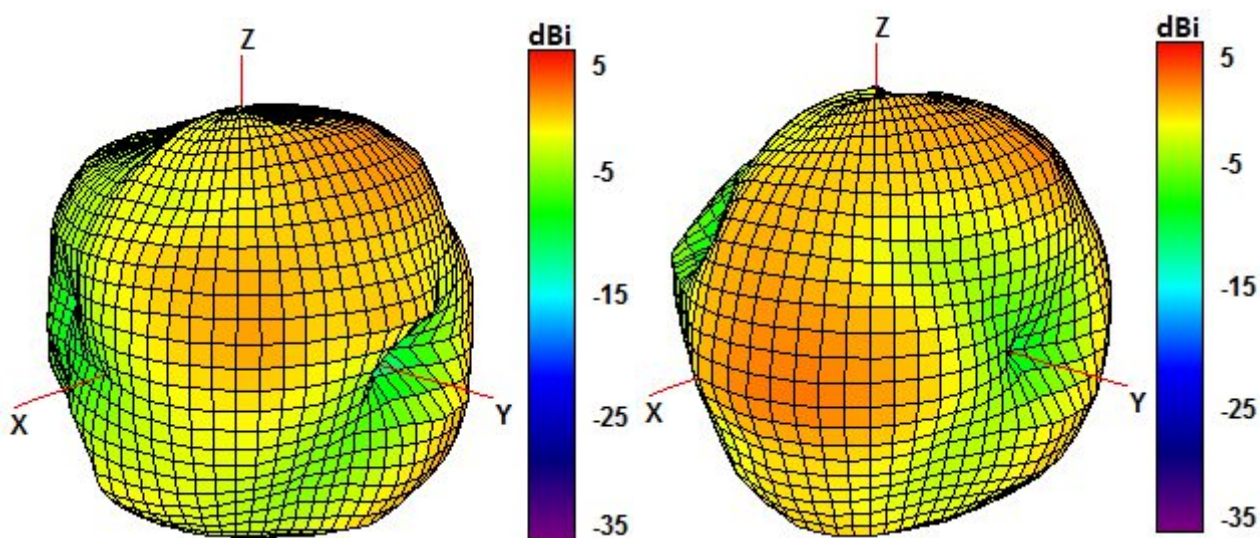

750 and 850 MHz Radiation pattern

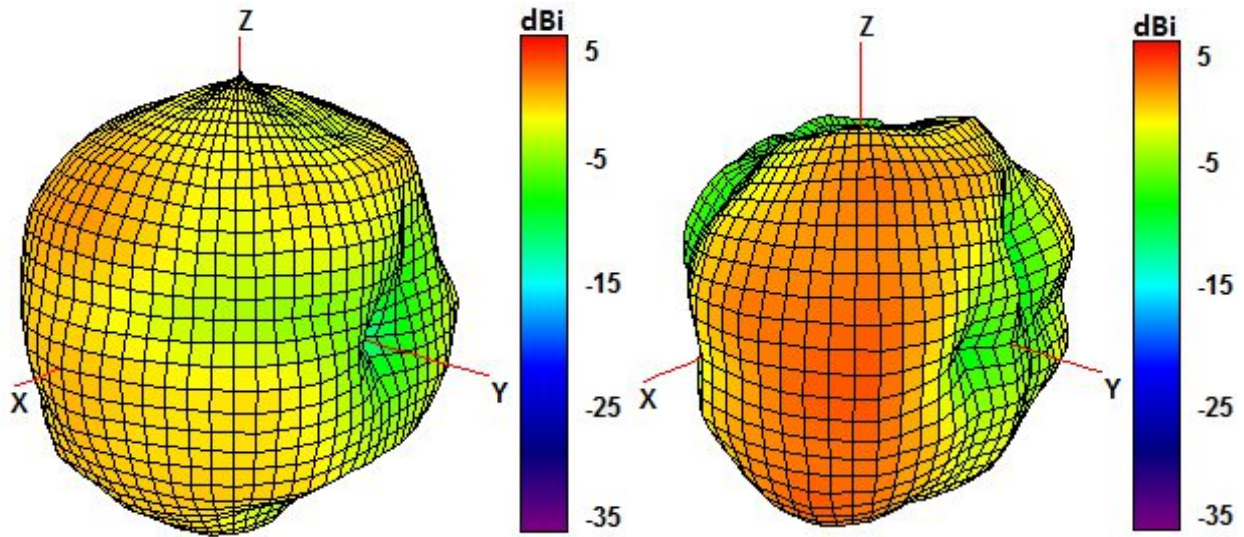

940 and 1750 MHz Radiation pattern

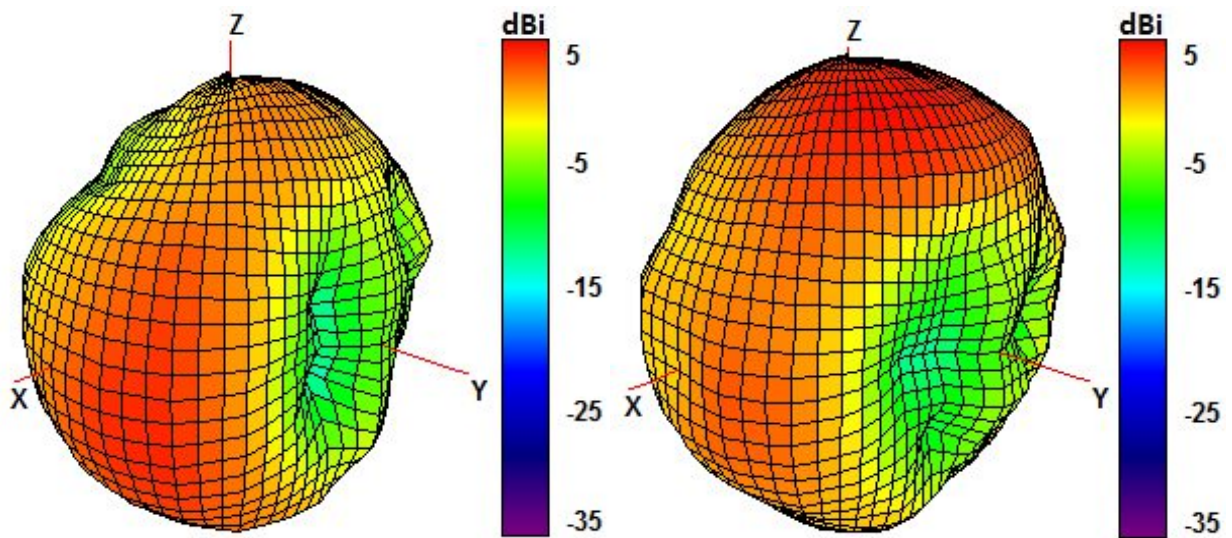

1850 and 1950 MHz Radiation pattern

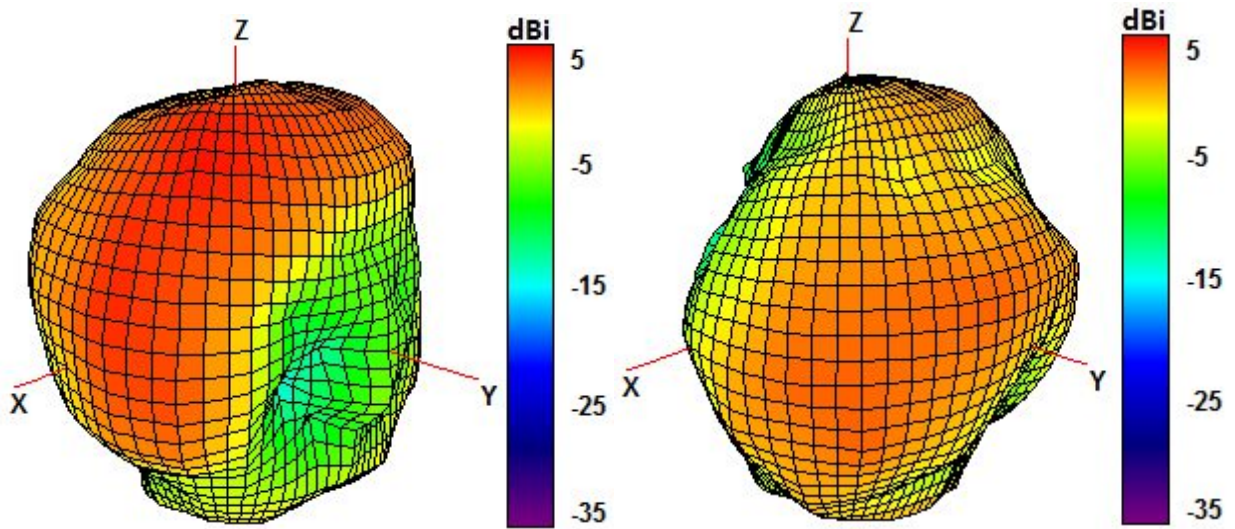

2100 and 2600 MHz Radiation pattern

Cable 2: CELLULAR/LTE

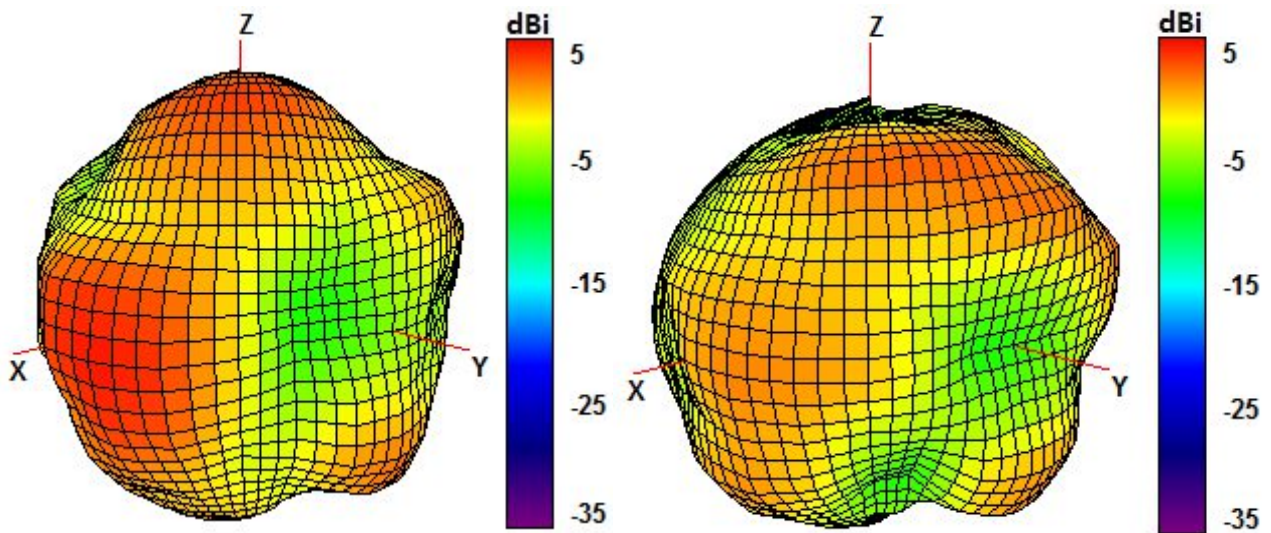

750 and 850 MHz Radiation pattern

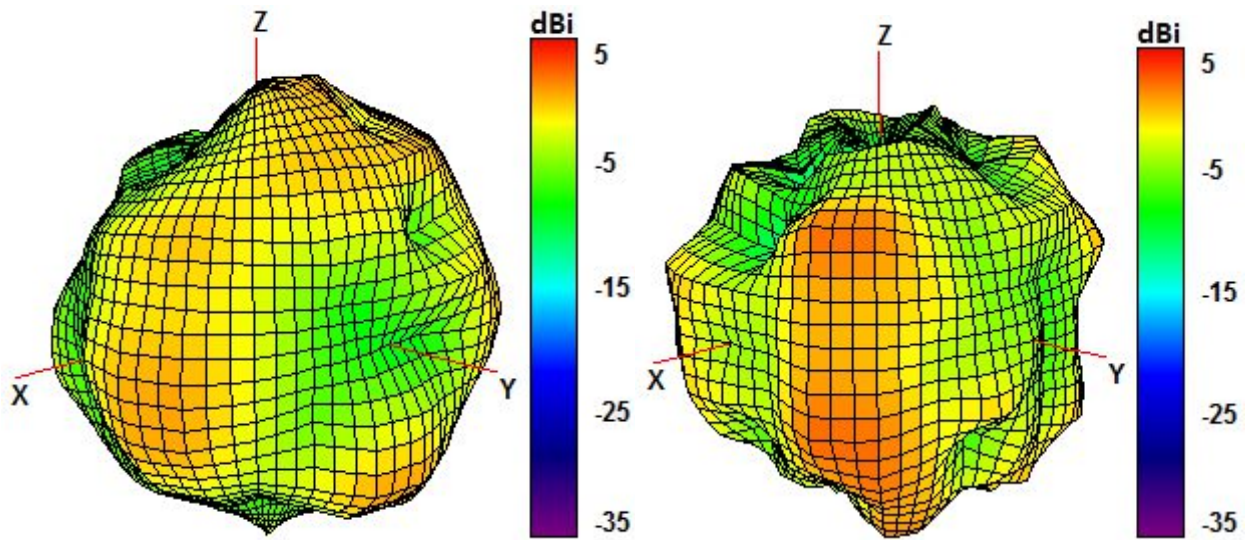

940 and 1750 MHz Radiation pattern

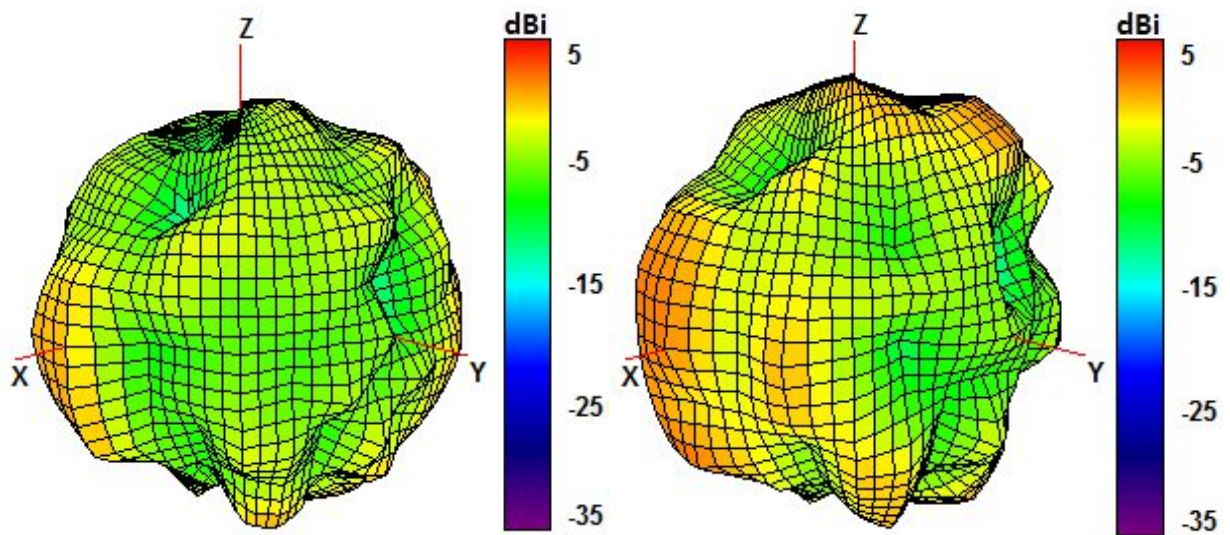

1850 and 1950 MHz Radiation pattern

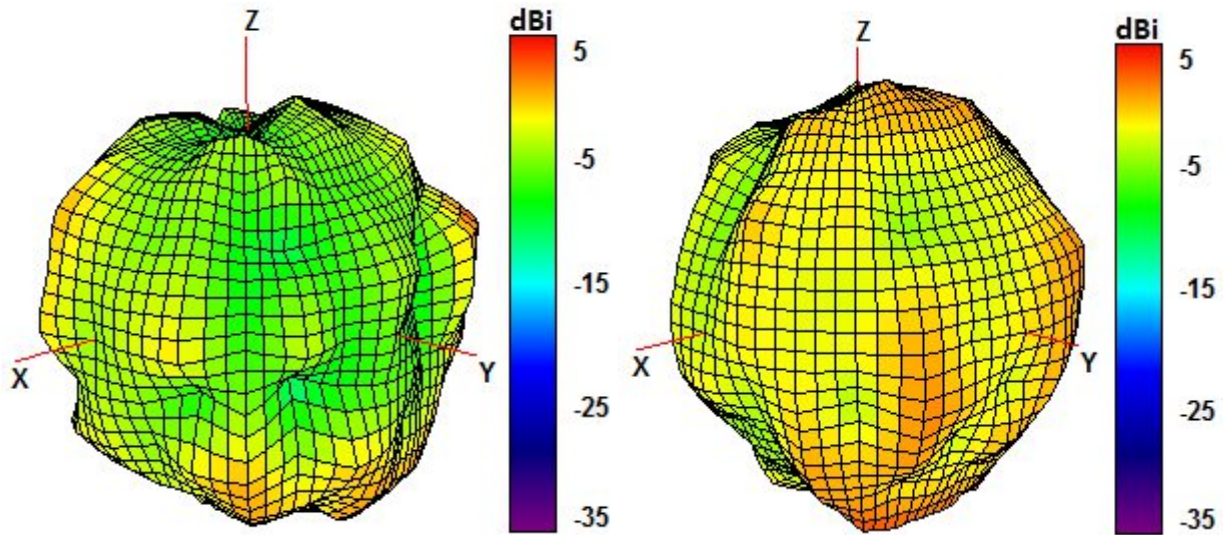

2100 and 2600 MHz Radiation pattern

Cable 3: 2.4/5.0 GHz ISM

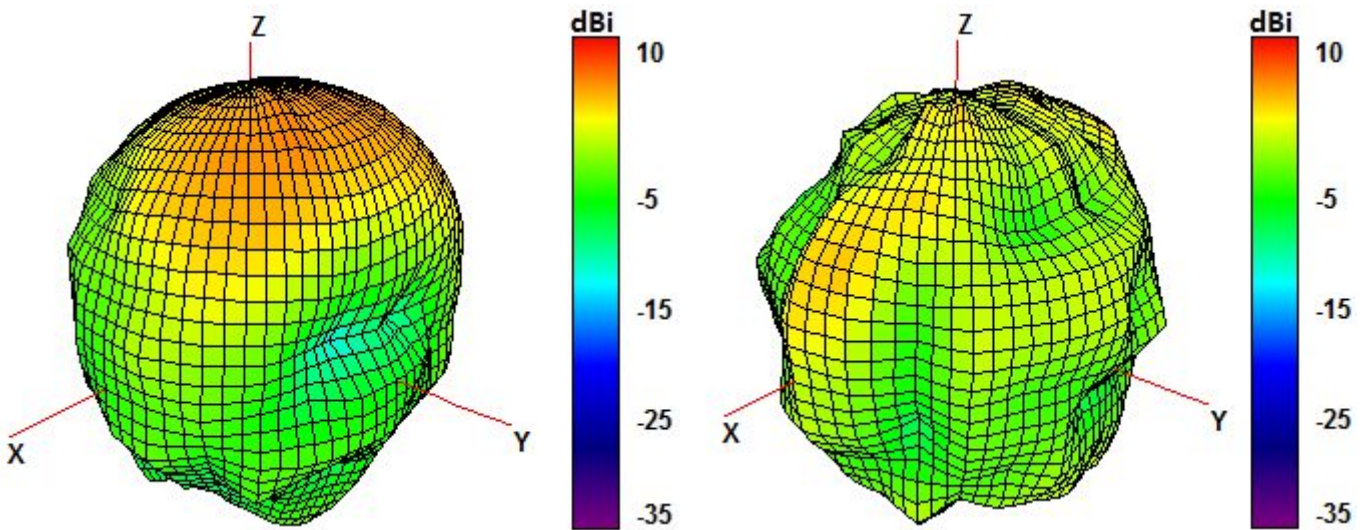

2450 and 5500 MHz Radiation pattern

Cable 4: 2.4/5.0 GHz ISM

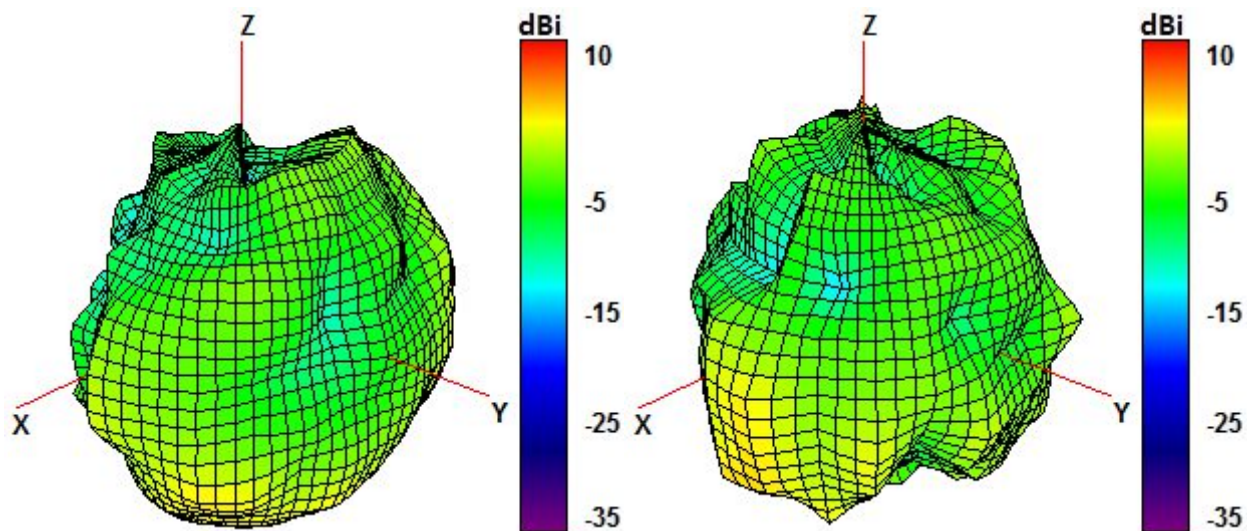

2450 and 5500 MHz Radiation pattern

4. Antenna drawings

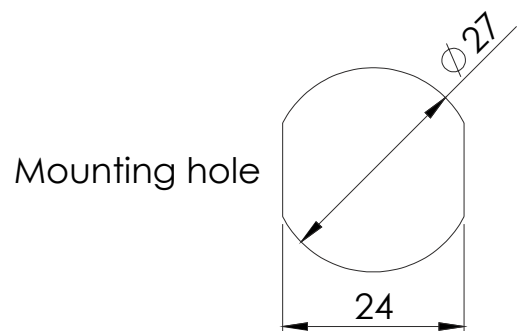
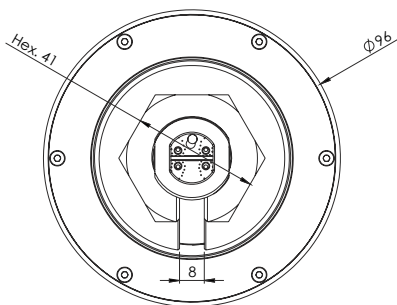
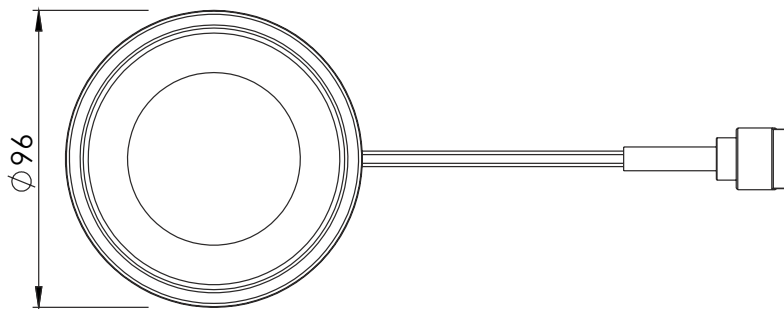
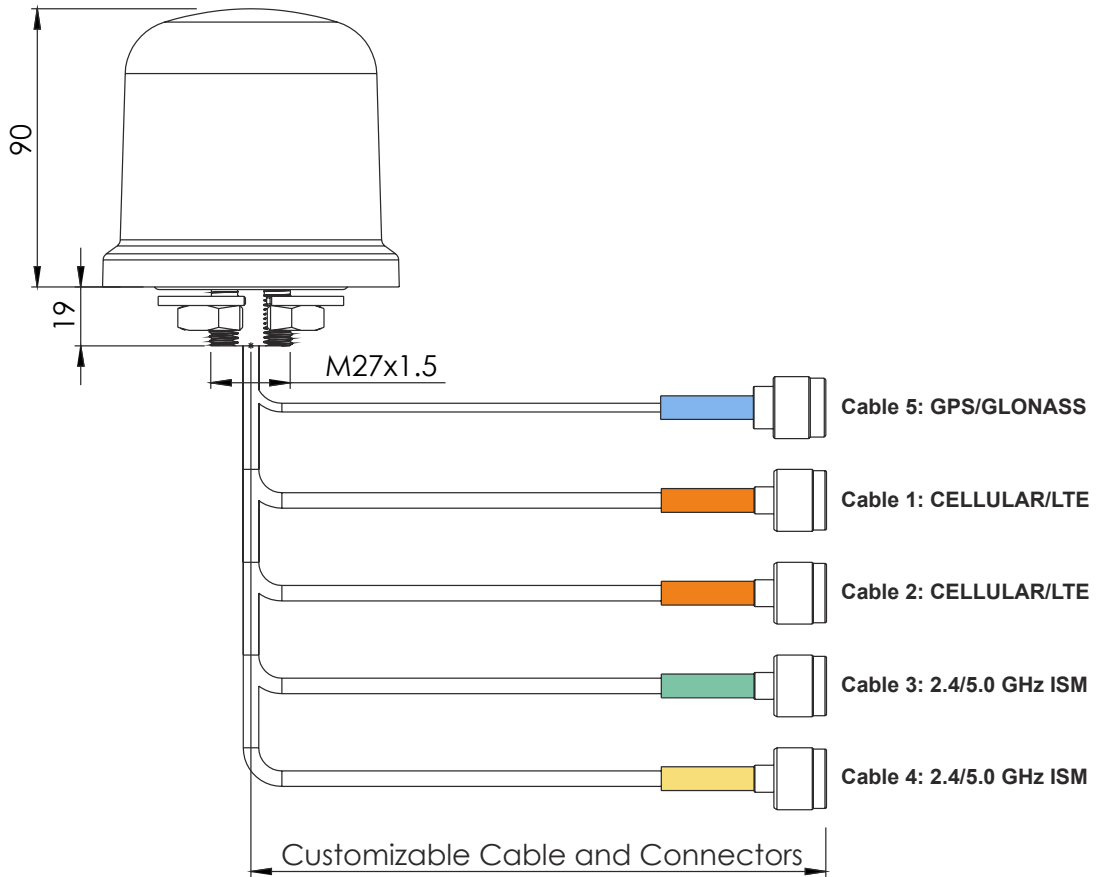

5. Jumper cables drawings - Optional

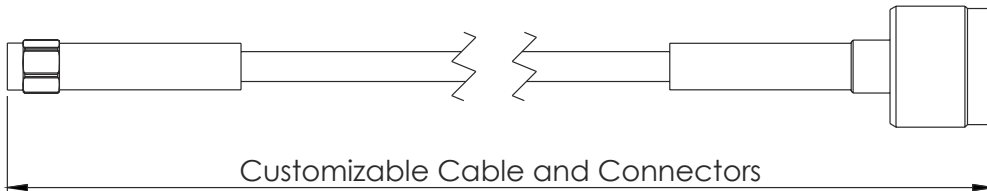

C318N-LMR195-C91N OST - 2x

Cable 1 and 2: CELLULAR/LTE - Shrink tube Orange d6,4

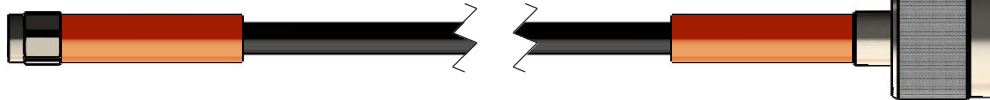

C318N-LMR195-C91N BST

Cable 5: GPS/GLONASS - Shrink tube Light blue d6,4

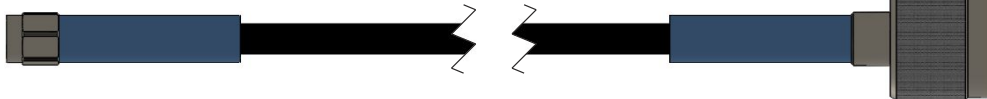

C318N-LMR195-C151N GST

Cable 3: 2.4/5.0 GHz ISM - Shrink tube green d6,4

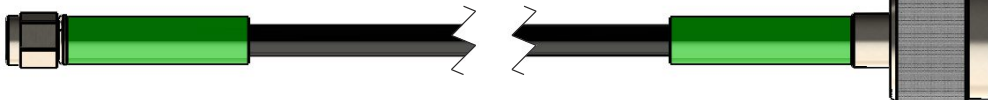

C318N-LMR195-C151N YST

Cable 4: 2.4/5.0 GHz ISM - Shrink tube yellow d6,4

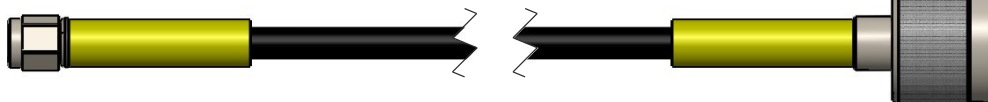

5. Antenna Images

