



# 2J660B 2J660BG (Datasheet)

**Type**  
**Frequencies**

Combined antenna  
AMPS (850 MHz)  
GSM (900 MHz)  
GPS/GLONASS/GALILEO (1572 – 1610 MHz)  
DCS (1800 MHz)  
PCS (1900 MHz)  
3G (UMTS 2.1 GHz)  
WIFI / BLUETOOTH (2.4 GHz)

**Mounting**  
**Revision**

Body Mount  
02



  
P. Tipul

  
D. Noble



## 1. PRODUCT SELECTOR

<b>2J660B</b>	GPS L1/Galileo L1 version
<b>2J660BG</b>	GPS/GLONASS/GALILEO version

## 2. SPECIFICATION

### 2.1. Electrical Specifications

#### Mobile (Cable 1)

Frequencies	AMPS (850 MHz) GSM (900 MHz) DCS (1800 MHz) PCS (1900 MHz) 3G (UMTS 2.1 GHz) WIFI / BLUETOOTH (2.4 GHz)
Impedance	50 Ohms
Polarization	Linear
Gain	2.2 dBi Max
VSWR	<2:1
Power handling	50W

#### Navigation (Cable2)

	<b>2J660B</b>	<b>2J660BG</b>
Frequencies	GPS (1575.42 MHz) GALILEO L1 (1575.42 MHz)	GPS (1575.42 MHz) GALILEO L1 (1575.42 MHz) GLONASS (1592 - 1610 MHz)
Impedance	50 Ohms	
Noise figure	1.15dB	
Polarization	RHCP	
Patch Gain	3dBiC min at zenith.	
LNA Gain	26dB at 3V, 27dB at 5V	
VSWR	<1.2:1	
Voltage supply	2.7V - 5.5V	
Current	15mA - 25mA	
Power (max.)	138mW	

### 2.2. General Specification

Operating temperature	-40°C to +85°C
IP rating	IP67

### 2.3. Connection Specifications

**Cable 1 (Mobile):**

Connector type: FME female  
 Cable: RG174U  
 Cable length: 250 cm

**Cable 2 (Navigation):**

Connector type: SMA male  
 Cable: RG174U  
 Cable length: 250 cm

For different cable or connector type please our sales team.

### 2.4. Mechanical Specifications and Dimensions

Material: Lid: ABS / Base: Zamak / Gasket: TPE  
 Max. Dimensions: 77.3 mm x 15 mm (D x H after mounting)  
 Weight: 200 g ‘weight with connection above’  
 Colour: Black (for different colours please ask our sales team)  
 Mounting hole:
 

- Square 15mm x 15mm
- Diameter 19mm

 Max. surface thickness: 4.5mm (for thicker surface ask our sales team)  
 Recommended torque: 6 Nm  
 Wrench size: 22mm

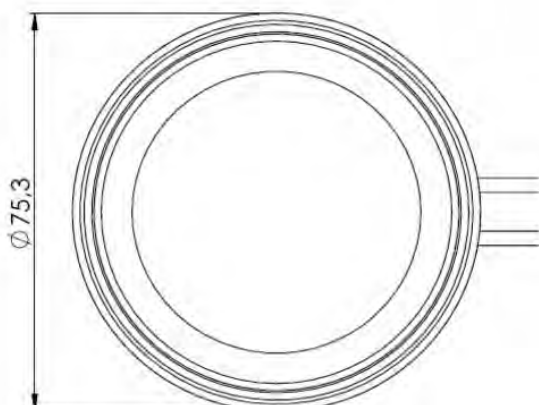
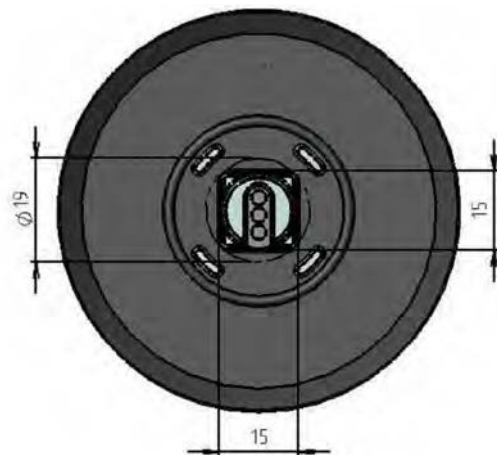
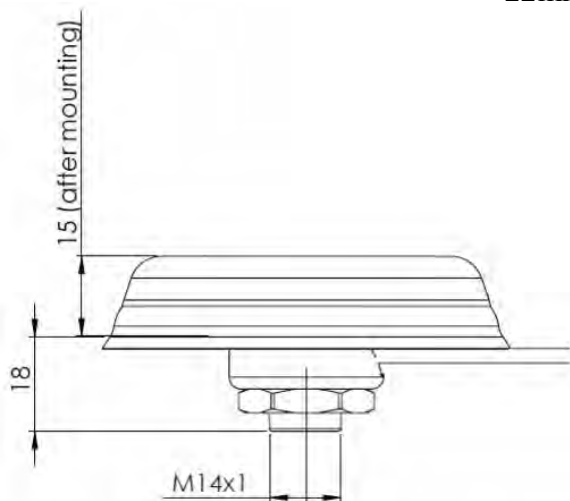

Basic shape of base



## Mounting holes

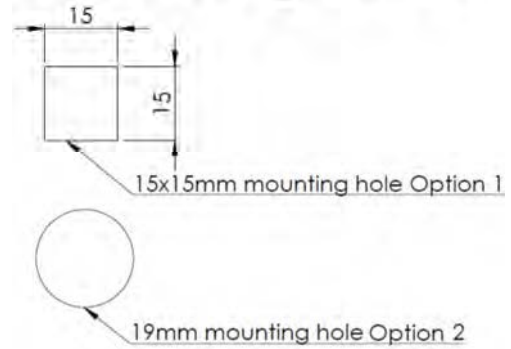

Optional shape of base with full thread



## Mounting hole

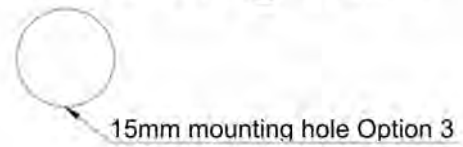

Screw M14x1



### 3. MEASUREMENT

#### 3.1. S11

- Tested with 50cm cable length on 50 cm x 50 cm ground plane.

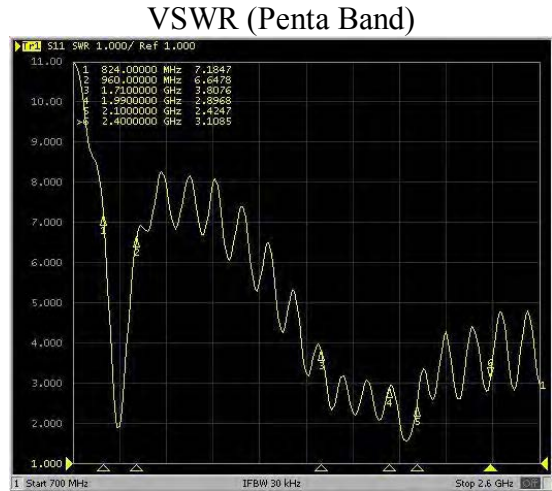
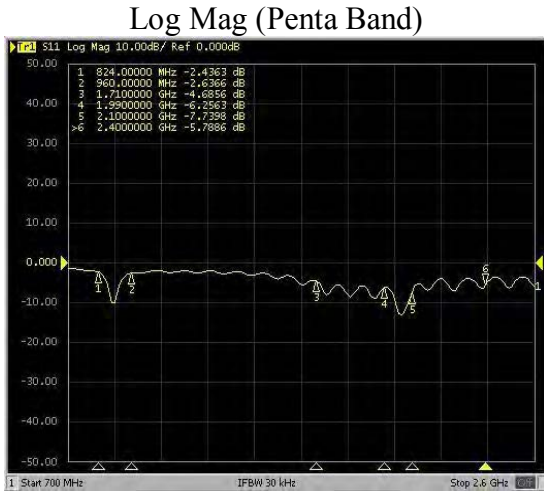

- Tested with 2.5m cable length on 50 cm x 50 cm ground plane.

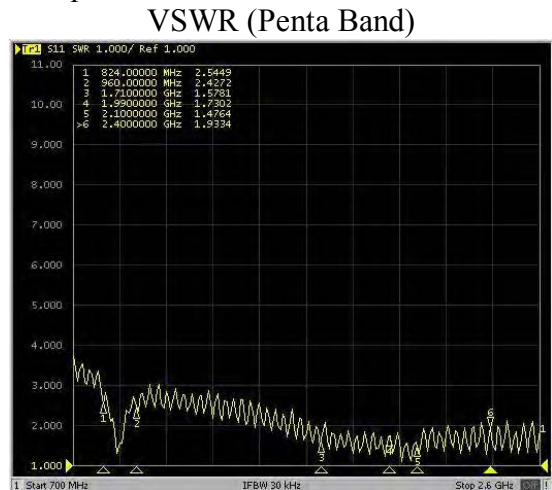
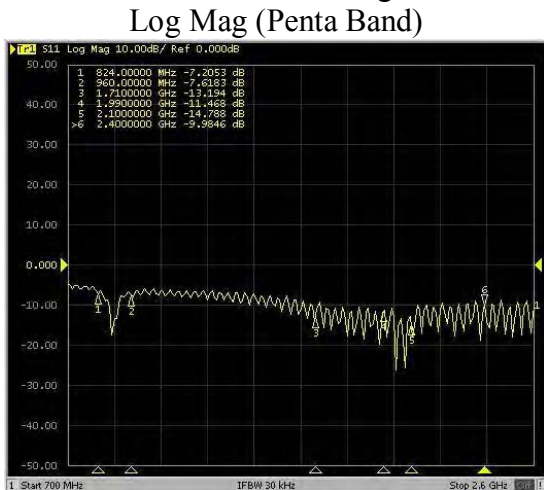

GNSS:

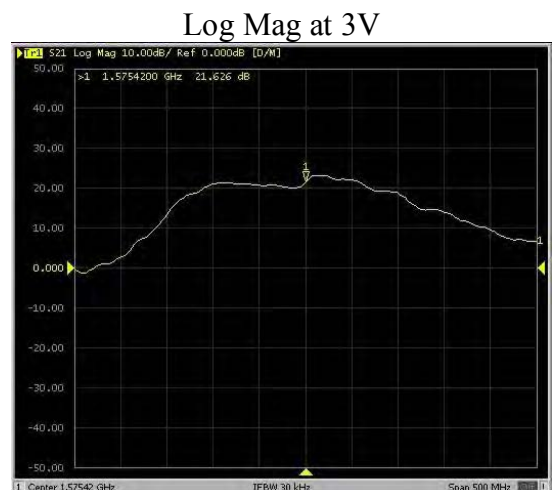
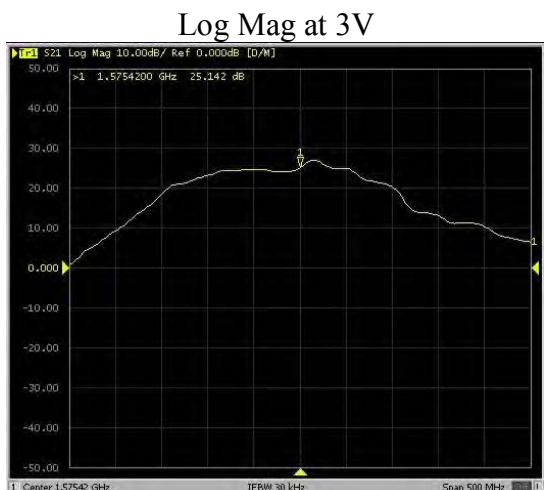

Tested with 2.5m cable length - RG174 with C20N

Tested with 5m cable length - RG174 with C20N

### 3.2. 3D radiation pattern

#### 3.2.1. GSM

- Tested with 30cm cable length on 25 cm x 25 cm ground plane.

850MHz  
Freq = 0.8500GHz Az= 45 EL= 45

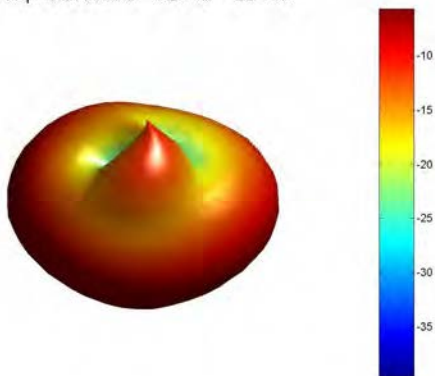

900MHz  
Freq = 0.9GHz Az= 45 EL= 45

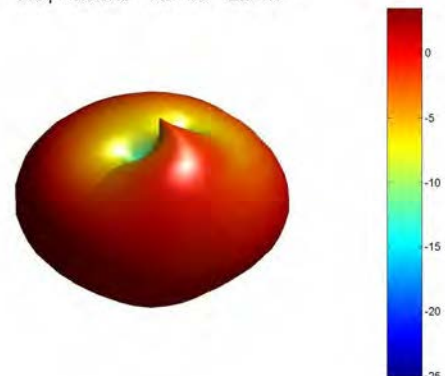

1800MHz  
Freq = 1.8GHz Az= 45 EL= 45

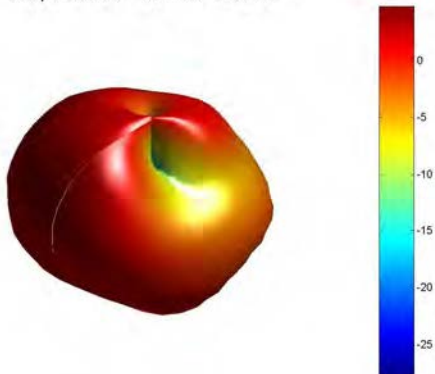

1900MHz  
Freq = 1.9GHz Az= 45 EL= 45

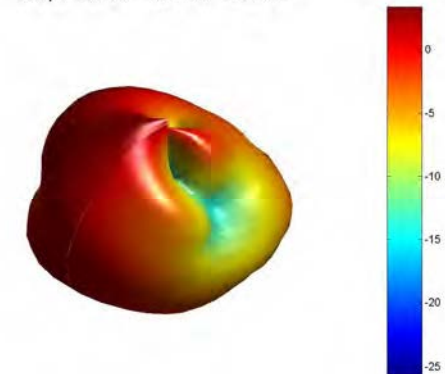

2100MHz  
Freq = 2.1GHz Az= 45 EL= 45

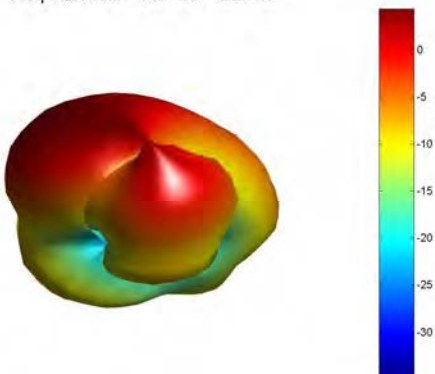

2400MHz  
Freq = 2.4GHz Az= 45 EL= 45

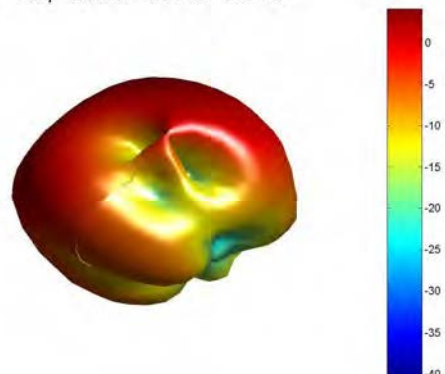

### 3.2.2. GNSS

- Tested with 30cm cable length on 25 cm x 25 cm ground plane and 5V power supply.

1575.42MHz  
Freq = 1.5754GHz Az= 45 EL= 45

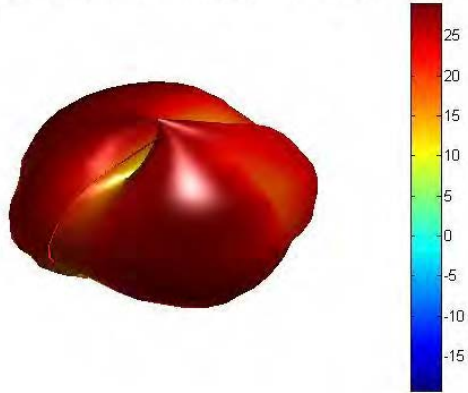

1610MHz  
Freq = 1.6104GHz Az= 45 EL= 45

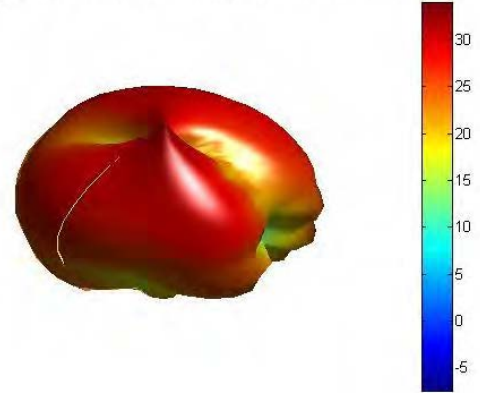

## 4. IMAGES

