

# 2J6510B

## 433 MHz ISM Screw Mount

### Key Features

#### 433 MHz ISM

- 433-435 MHz

Screw Mount

Anti-Rotation Mechanism

Ground Plane Dependent

Customizable Cable and Connector

Dimensions  $\varnothing$  146 x 31.5 mm

Certificates: IK09, IP67, IP69K



## 1. Antenna and electrical specifications

Parameters	433 MHz ISM Antenna
<b>Standards</b>	ISM, LoRa
<b>Band (MHz)</b>	433 MHz
<b>Frequency (MHz)</b>	433-435
<b>Return Loss (dB)</b>	~-18.7
<b>VSWR</b>	~1.3:1
<b>Efficiency (%)</b>	~58.3
<b>Peak Gain (dBi)</b>	~2.9
<b>Average Gain (dB)</b>	~-2.3
<b>Impedance (Ohm)</b>	50
<b>Polarisation</b>	Linear
<b>Radiation Pattern</b>	Omni-Directional
<b>Max. Input Power (W)</b>	50
<b>Connector Type</b>	SMA-Male Standard (Other Connectors Available)
<b>Cable Length</b>	300 cm Standard (Any Cable Length Available)
<b>Cable Type</b>	RG58 Standard (Other Cables Available)

### Antenna Measurement Conditions:

Mounted on 60 x 60 cm Metal Plate

200cm of RG58 Cable

Measured in Certified CTIA 3D Anechoic Chamber

## 2. Mechanical and environmental specifications

Specifications	2J6510B
<b>Mounting Type</b>	Screw Mount
<b>Dimensions (mm)</b>	Ø 146 x 31.5
<b>Radome</b>	ABS
<b>Radome color</b>	Black
<b>Antenna Base</b>	Zamak
<b>Gasket</b>	TPE
<b>Operating Temperature (C)</b>	-40 to +85
<b>Storage Temperature (C)</b>	-40 to +85
<b>Substance Compliance</b>	RoHS
<b>Certificates</b>	IK09, IP67, IP69K

### 3. Antenna parameters

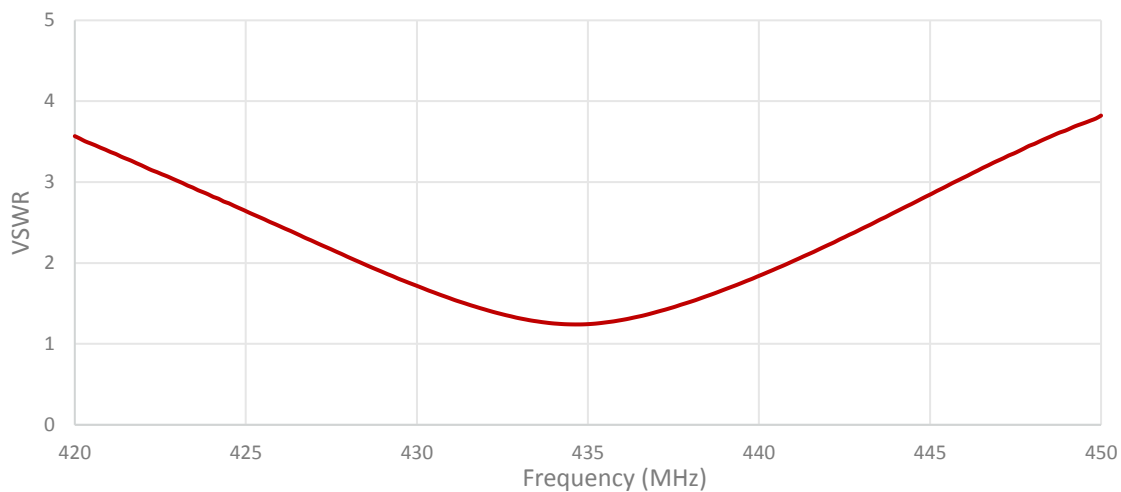
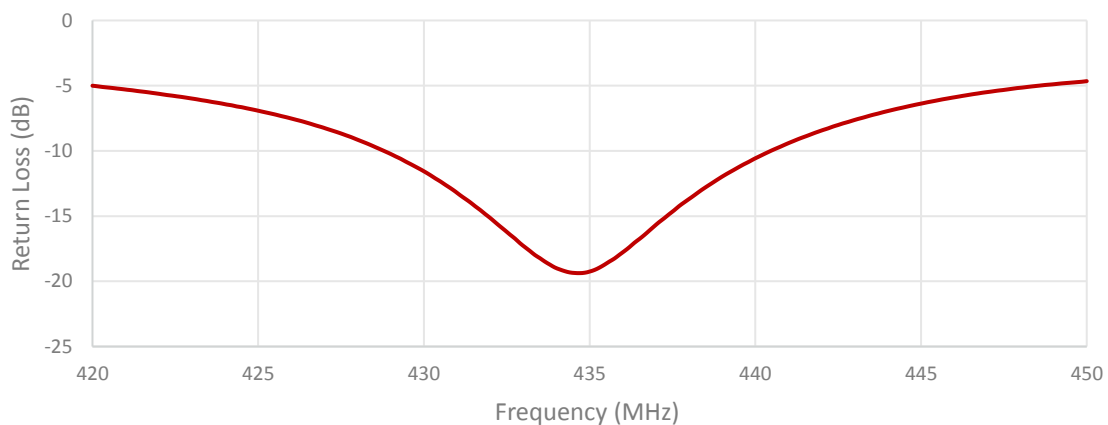

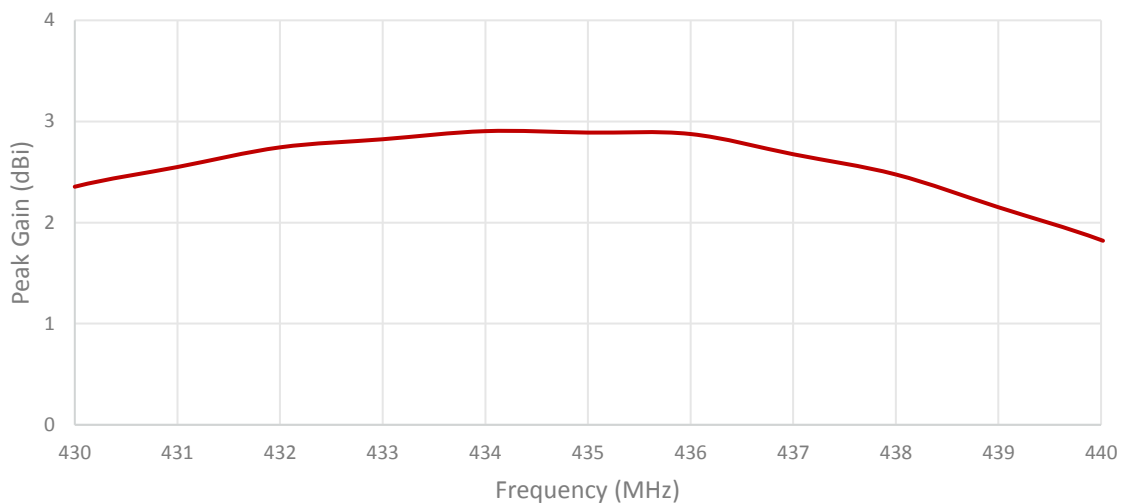
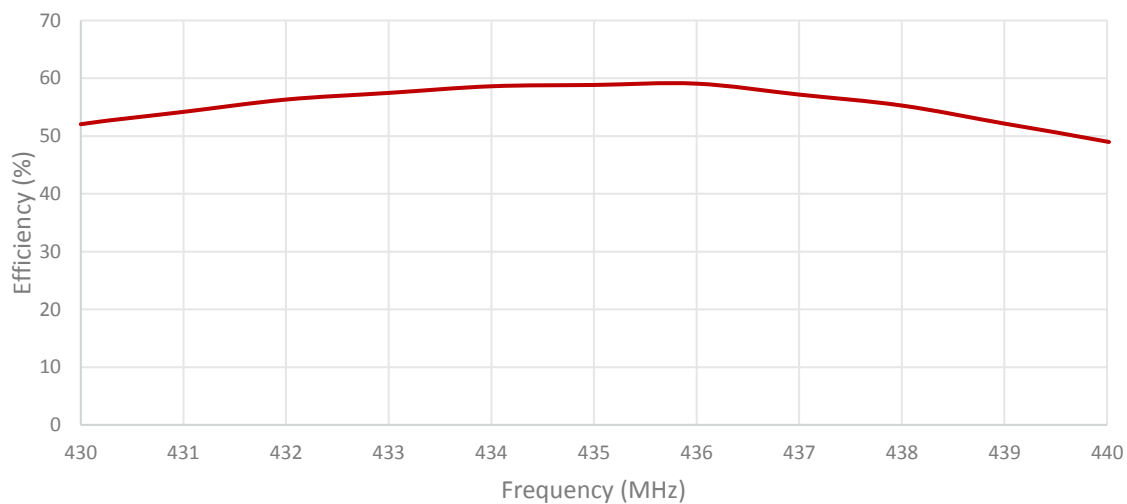

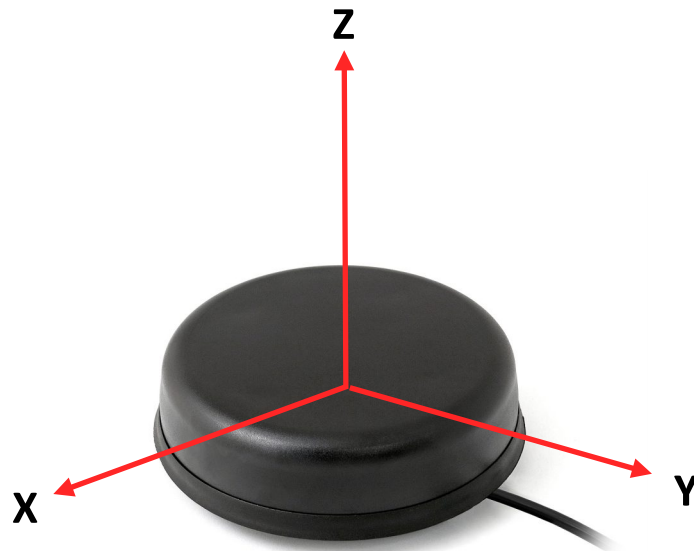
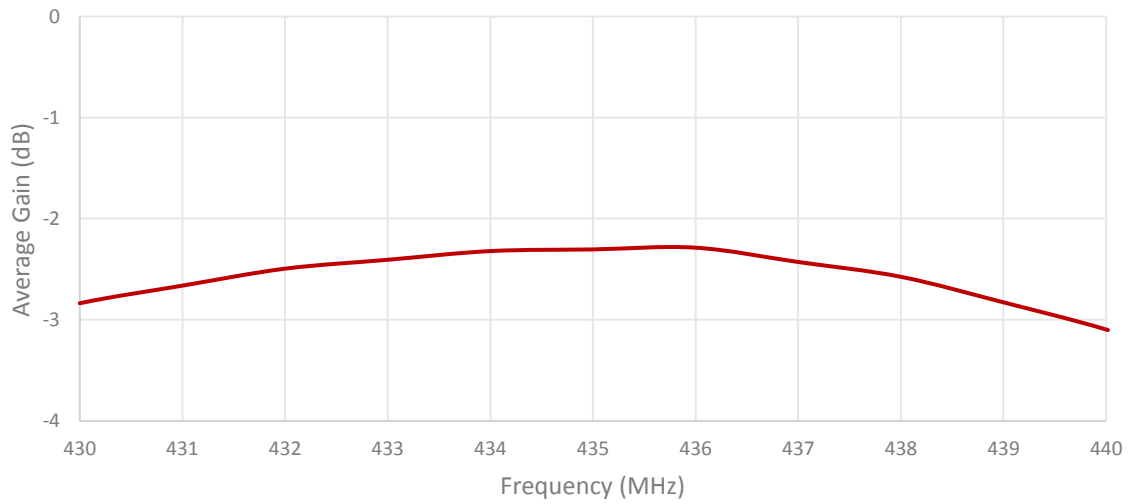

Radiation pattern reference

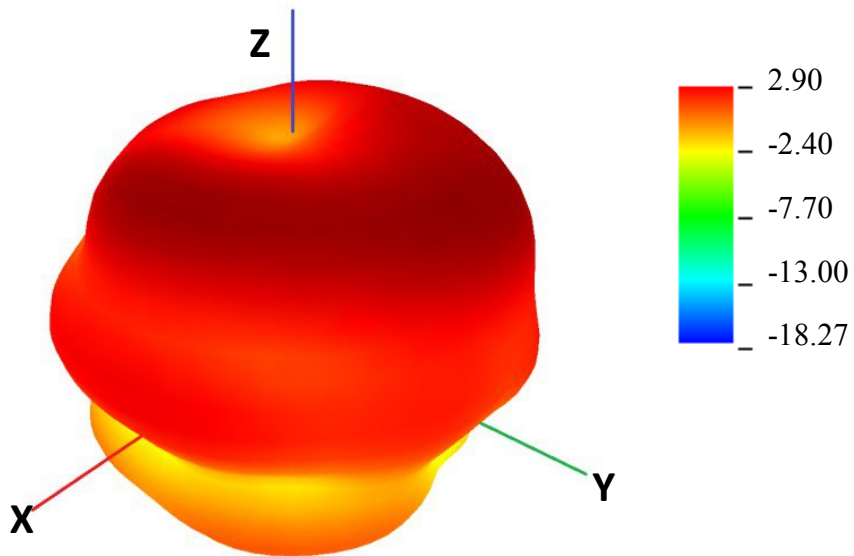

433 MHz Radiation pattern

## 4. Antenna drawings

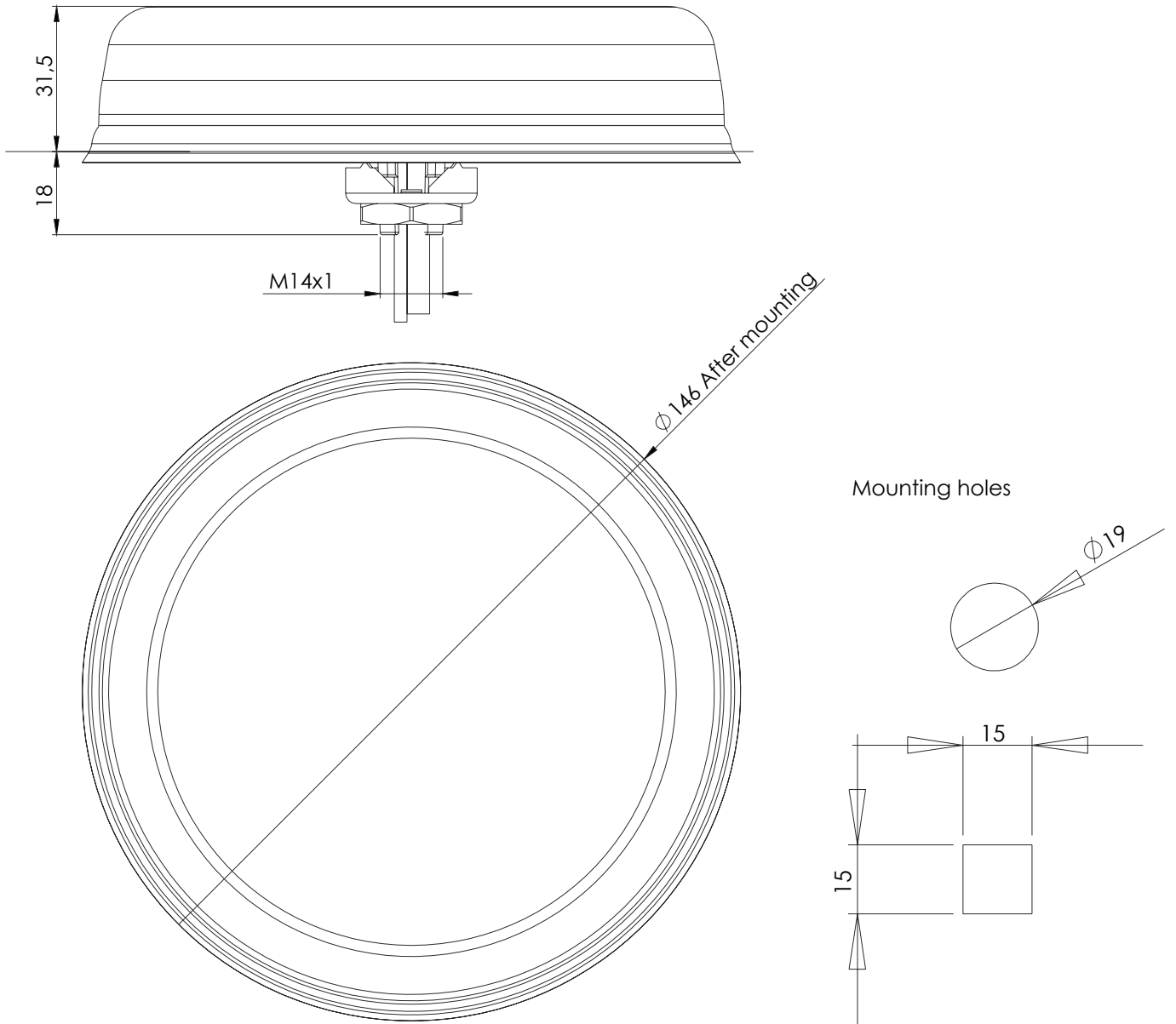

## 5. Antenna Images

